

CITY OF Rancho Cordova

Incorporated July 1, 2003



PEDESTRIAN MASTER PLAN



MARCH 2011

PEDESTRIAN MASTER PLAN

*CITY OF RANCHO CORDOVA
2729 PROSPECT PARK DRIVE
RANCHO CORDOVA, CA 95670
PHONE: (916) 851-8700
FAX: (916) 851-8787*

MARCH 2011

Executive Summary

The City of Rancho Cordova Pedestrian Master Plan is the third and final master plan identified in the Circulation Element of the City's General Plan. The Pedestrian Master Plan combines with the Bicycle Master Plan and the Transit Master Plan to organize projects and programs that will serve alternative modes for travel.

The City's pedestrian policy framework focuses on creating desirable walking opportunities for residents and workers who are looking for non-auto options to get to schools, parks, shopping or work. They may also want easy walking access to the transit system for longer trips. Other General Plan policies recognize that compact development and mixed use development will improve pedestrian access in the future, and current policies and programs will be continued that will serve our school aged residents and disadvantaged populations.

The Bicycle Master Plan creates a city trail system that will expand options for pedestrian travel. The Pedestrian Plan goes further to identify improvements in existing neighborhoods such as sidewalk gap fill, sidewalk repair, intersection access improvements and midblock crosswalks. The plan also contemplates upgrading existing community walkways and looks ahead to an expanded street light program. Lastly, the Plan coordinates with the Neighborhood Traffic Calming Plan and the Americans with Disabilities Act Access Plan to serve a broad range of pedestrian needs.

Many improvements contemplated by the Pedestrian Plan are supported by unique City standards that help to build projects that are useful to residents. The City's complete streets effort positions Rancho Cordova with a growing number of communities that want to build desirable transportation facilities serving all modes of travel.



Contents

EXECUTIVE SUMMARY

CHAPTER 1: INTRODUCTION

Purpose of this Plan 1-1

Key Issues..... 1-1

Key Projects 1-2

The Planning Process 1-3

Plan Organization 1-3

 How to Use this Plan 1-3

CHAPTER 2: EXISTING CONDITIONS

Setting 2-1

Demographic Profile 2-1

Related Plans, Programs, and Projects 2-3

 City Plans that Support Pedestrian Improvements 2-3

 Programs and Projects 2-4

 20 tons in 2010 2-4

Community Outreach Results 2-5

 Legacy Outreach by Sacramento County 2-5

 Rancho Cordova Pedestrian Master Plan Outreach 2-6

 Targeted Outreach 2-8

 Workshop: July 2010 2-12



CHAPTER 3: PEDESTRIAN POLICY FRAMEWORK

Existing General Plan Goals 3-1

- From the Circulation Element..... 3-1
- From the Open Space and Trails Element 3-1
- From the Land Use Element 3-2
- From the Urban Design Element..... 3-2
- From the Safety Element..... 3-2
- From the Air Quality Element..... 3-2

Pedestrian Master Plan Goals, Policies, and Actions 3-2

Pedestrian Standards 3-6

- Complete Streets 3-6
- Pedestrian Refuge 3-7
- Pork Chop Island 3-7

CHAPTER 4: NEEDS ASSESSMENT

Pedestrian Demand 4-1

- 2009 Pedestrian Surveys 4-5

Pedestrian Collision Analysis 4-8

Barriers to Pedestrian Activity 4-8

- Highway 50 4-9
- Localized Barriers to Travel..... 4-9
- Folsom Boulevard Sidewalk replacement..... 4-9
- Land Use Concepts that Eliminate Barriers 4-9
- Public Transportation 4-10



TABLE OF CONTENTS

CHAPTER 5: IMPLEMENTATION

Sidewalk Infill Opportunities	5-3
Signalized Intersection Improvements	5-3
Sidewalk Repair	5-4
Midblock Crossings	5-4
Pedestrian Pathway Upgrades	5-5
Street Lighting.....	5-5
Unmarked Access Discussion for American River Parkway	5-6
Funding Opportunities	5-6
Federal and State Funding Sources	5-7
Local Funding and Financing Sources	5-8
Partnership Opportunities	5-8

APPENDIX A: PEDESTRIAN STANDARDS

APPENDIX B: PEDESTRIAN COUNT DETAILS



LIST OF TABLES

Table 2.1: Population Diversity..... 2-2

Table 2.2: Number of Residents and Workers in Rancho Cordova and Nearby
Communities 2-2

Table 5.1: Pedestrian Master Plan Cost Summary 5-1

Table 5.2: Planning Estimate for Intersection Improvements 5-4

Table 5.3: Planning Estimate for Street Lighting..... 5-6

LIST OF FIGURES

Figure 1.1: Study Area 1-4

Figure 4.1: Pedestrian Generators 4-3

Figure 4.2: 2009 Pedestrian Survey Locations 4-6

Figure 5.1: Pedestrian Improvements 5-2





Chapter 1:
INTRODUCTION





CHAPTER 1

Introduction

The pedestrian experience in Rancho Cordova varies greatly by location, from peaceful multi-use paths through Anatolia to busy Folsom Boulevard transit hubs. People who live, work, and play in Rancho Cordova walk to school and work, and walk to parks for exercise and recreation along multi-use paths. Some of Rancho Cordova's most bustling pedestrian zones are located at light rail stations, where train passengers are walking to connect with other transportation modes or to other destinations on foot.

This Master Plan restates the City's commitment to providing safe and convenient pedestrian access to a diversity of destinations throughout the City, from new development areas to established neighborhoods.

PURPOSE OF THIS PLAN

This Master Plan strengthens the City's existing policy framework by providing specific information related to pedestrian infrastructure and demand, as well as updated policy language. Additionally, this Plan includes an implementation chapter that outlines the highest-priority pedestrian projects in Rancho Cordova and the estimated cost to complete them. This Plan provides an update on the overall state of the pedestrian network as well as an assessment of the level of effort needed to improve the network citywide.

KEY ISSUES

A number of key issues emerged from this planning process:

Need for grade-separated crossings. Major barriers to pedestrian activity in Rancho Cordova, particularly Highway 50 and the Folsom South Canal, will require pedestrian crossing opportunities such as bridges or undercrossings.



Need to close sidewalk gaps and improve substandard sidewalks. An incomplete sidewalk network is a primary barrier to pedestrian activity, particularly for vulnerable pedestrians such as small children and seniors or people with disabilities. The City is currently working to complete the sidewalk network and implement the Americans with Disabilities Act (ADA) Transition Plan to ensure that Rancho Cordova’s sidewalk network provides accessible connections for all.

Need for additional midblock crossings. Long city blocks and the proliferation of large arterial roadways in Rancho Cordova means that pedestrians often need to walk significant distances between crossing opportunities. Midblock crossings are needed to provide safe crossings for pedestrians at intervals that allow more convenient access to destinations on all sides of busy roadways.

Trail connections are needed to ensure that residents, workers, and visitors have adequate alternative transportation options.

Need for additional multi-use trail connections. Rancho Cordova is planning strategically for a comprehensive network of multi-use pathways. These trail connections are needed, in time with new development, to ensure that residents, workers, and visitors have adequate alternative transportation options and recreational opportunities.

Need for integrated developments. Walking for transportation must be convenient in order to have broad appeal. Locating a mix of land uses in close proximity enables residents to walk to work, workers to walk to lunch and shopping, and schoolchildren to walk to school independently. Neighborhoods in Rancho Cordova need to incorporate more integrated opportunities for daily walking trips.

Need for additional public transportation options. Due to the existing land use pattern and distance between significant destinations in Rancho Cordova, more public transportation options—such as streetcars and the Rancho CordoVan—are needed to help pedestrians extend their walking trips.

KEY PROJECTS

The pedestrian improvement projects proposed by this Master Plan respond to the needs identified during the planning process and outlined above under Key Issues. These projects will make the existing pedestrian network more accessible, convenient, and safe. Trails and pedestrian infrastructure will be expanded significantly in new development areas. New development will integrate land uses and provide walkable neighborhoods based on new standards. Existing neighborhoods will be upgraded as projects move forward.



Key project types include:

- Midblock crossings
- Sidewalk infill
- Proposed pedestrian connections
- Grade-separated crossings/bridges over pedestrian barriers
- Lighting
- Intersection improvements/pedestrian countdown signals
- Pedestrian pathways near schools

THE PLANNING PROCESS

This Master Plan resulted from a collaborative process between City staff and members of the community. This Plan incorporates the 2005 Sacramento County Pedestrian Master Plan process, which was initiated prior to Rancho Cordova’s cityhood. Significant efforts have been made to update and expand the pedestrian demand data provided by that plan and to observe the most recent pedestrian trends in Rancho Cordova. Targeted outreach to schools and senior centers—key pedestrian populations—was conducted as part of this planning process. Workshops held in 2009 and 2010 provided community members with a forum to learn about and participate in the planning process. Finally, the regular involvement of key stakeholder groups, such as WalkSacramento and Bicycle Advocates for Rancho Cordova, has greatly strengthened this Plan. Figure 1.1 shows the study area for the Pedestrian Master Plan.

PLAN ORGANIZATION

HOW TO USE THIS PLAN

This Plan comprises five chapters, beginning with an overview of the existing conditions for walking in Rancho Cordova. The Plan includes policies and standards for development of pedestrian facilities and concludes with detailed cost estimates for the improvement outlined in this Master Plan. Different readers may focus on different components of the Plan.

If you are a resident, you may want to focus in on the proposed improvements described in Chapter 5: Implementation.

If you are a City staff member, you may want to read and understand the entire document, and you’ll want to focus on the policy framework provided in Chapter 4: Pedestrian Policy Framework.

If you are a member of the development community, you may be particularly interested in the policy direction provided by Chapter 4: Pedestrian Policy Framework as well as Chapter 5: Implementation.





STUDY AREA

- PARKS & REC AREAS
- LAKES AND RIVERS
- CREEKS
- RANCHO CORDOVA CITY LIMITS
- PLANNING AREA BOUNDARY

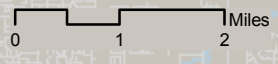
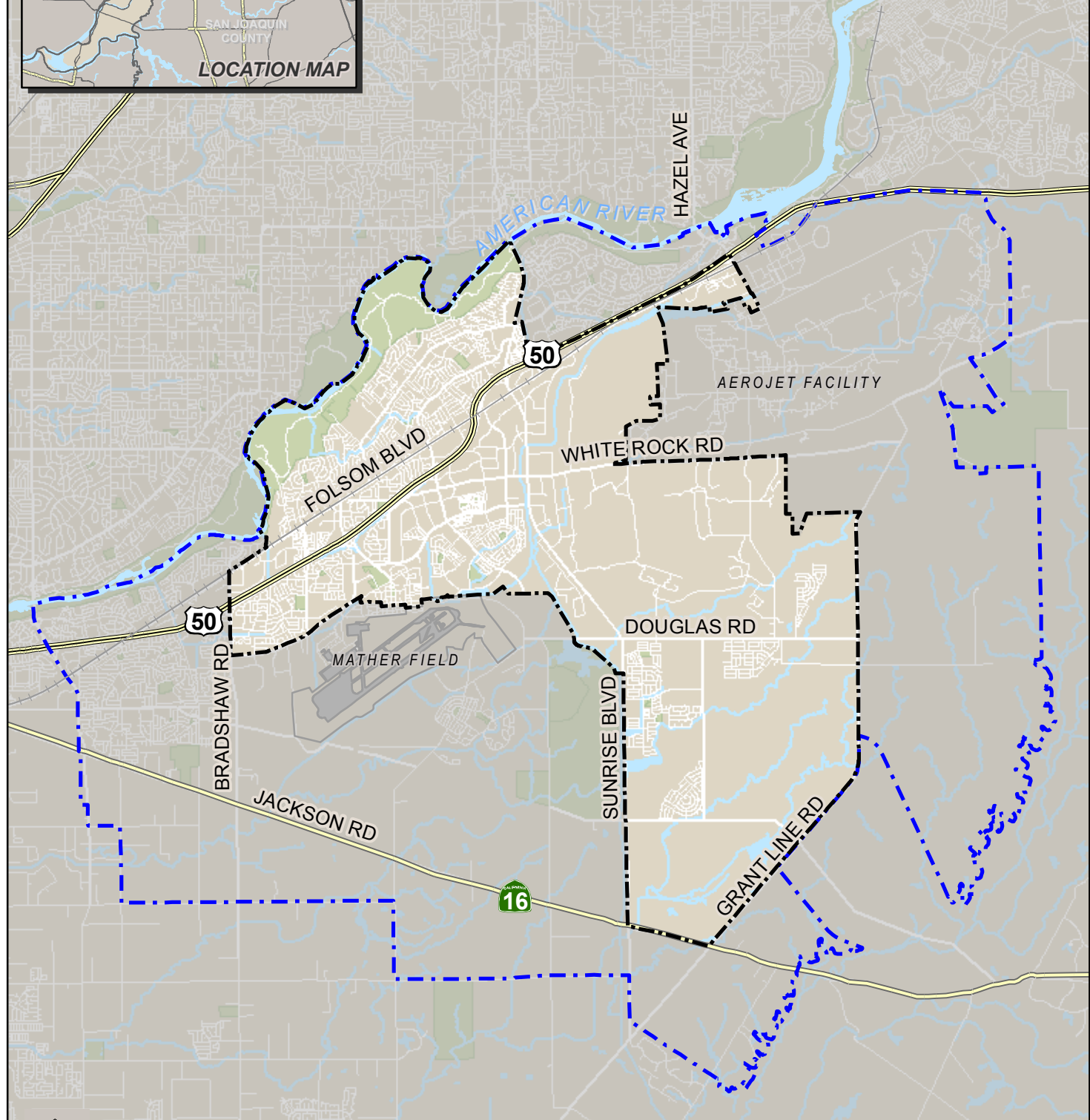
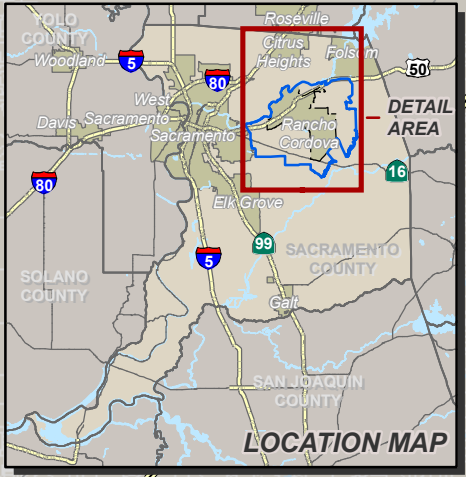

FIGURE 1.1



Chapter 2:
EXISTING CONDITIONS





2

CHAPTER 2

Existing Conditions

Rancho Cordova is a City with a commitment to walking as a mode of transportation. However, the existing land form and development pattern is at times challenging for pedestrians to navigate. This chapter outlines the existing conditions present for Rancho Cordova's pedestrians. This chapter also includes an overview of the existing plans and programs related to walking as a transportation mode. More detailed information on walking trends is included in Chapter 4, Needs Assessment.

SETTING

The City of Rancho Cordova is located to the east of the City of Sacramento and to the west of the City of Folsom, along Highway 50. Mather Field Air Base is located along the southwest boundary of the City, and the Aerojet Rocket Testing Facility is located to the east. The northern boundary of Rancho Cordova is defined by the American River. The City of Rancho Cordova, incorporated in 2003, is the third largest incorporated municipality in Sacramento County.

Rancho Cordova was largely settled during and after the Second World War, when it was home to a thriving military base and a hub for the emerging aerospace industry. The original development pattern relied heavily on vehicle transportation, leaving some residential areas without sidewalks and other pedestrian-friendly amenities. The military base is no longer active, although the site is now being used for both private and commercial general aviation.

Due to its proximity to the state capital and its accessibility by multiple transportation modes, Rancho Cordova has emerged as an important employment center within the greater Sacramento metropolitan region and the state.

DEMOGRAPHIC PROFILE

According to the California Department of Finance, as of January 1, 2009, the City of Rancho Cordova has a population of 61,817 people and 24,463 households. The average household size is 2.63 people. The U.S.



CITY OF RANCHO CORDOVA • PEDESTRIAN MASTER PLAN

Census Bureau estimates that in 2007, 14,712 residents were under the age of 18, and 3,827 residents were receiving a retirement income.

Rancho Cordova is the second largest employment center in the Sacramento region. The public and private sector businesses and organizations in Rancho Cordova employ close to 45,000 people.

The City has experienced significant growth in the recent past and anticipates continued growth into the future. The population is estimated to grow to 105,000 residents by 2020. The median income for Rancho Cordova households is \$46,529¹. The City has a diverse population as shown in Table 2.1 below.

Table 2.1: Population Diversity

Area	White	Hispanic or Latino	Black or African American	Asian	Two or More Races	Other
Rancho Cordova	53.6%	16.7%	11.8%	10.2%	6.3%	1.5%
Sacramento County	60.8%	19.3%	10.1%	13.7%	4.2%	11.1%
California	59.8%	35.9%	6.2%	12.3%	3.3%	18.4%

Source: City of Rancho Cordova, Demographic Profile, www.cityofranhocordova.org, September 2009

Rancho Cordova is one of the Sacramento region's most concentrated employment centers. It is home to many residents who are working age (over 16), as depicted in Table 2.2 below.

Table 2.2: Number of Residents and Workers in Rancho Cordova and Nearby Communities

City	Total Population	Total Number of Workers Over the Age of 16*	Total Number of Workers as Percentage of Total Population
Rancho Cordova	59,666	27,774	47%
Folsom	71,836	32,020	45%
Arden-Arcade	90,973	41,828	46%
Roseville	115,452	57,243	50%
Sacramento	446,530	197,856	44%

Source: American Community Survey 2007

*Refers to workers living in each area.

¹ American Community Survey 2007



RELATED PLANS, PROGRAMS, AND PROJECTS

The City of Rancho Cordova provides pedestrian improvements through Measure A Construction Grants, Community Development Block Grants, and other local resources. These improvements are programmed through the Pedestrian Improvement Program, Bikeway Improvement Program, Elderly and Disabled Access Improvement Program, and Neighborhood Traffic Management Program. As annual improvement efforts or other local improvements are identified, specific projects are contracted for construction.

The “new” Measure A expenditure requirements refocus project development approaches. Ongoing City programs will fall under two generalized categories. The Traffic Control and Safety Program will provide physical features and operational programs to improve the operation and safety of the local street and road network for all modes of travel and for persons with disabilities. The Safety, Streetscaping, Pedestrian, and Bicycle Facilities Program will construct, improve, or upgrade transportation facilities and corridors to provide bicyclists, pedestrians, and persons with disabilities safe and efficient travel routes and improve aesthetics along local streets and roads.

CITY PLANS THAT SUPPORT PEDESTRIAN IMPROVEMENTS

The **Pedestrian Master Plan** is intended to tie goals and policies identified in the 2006 General Plan to the pedestrian implementation programs. The Master Plan refines the pedestrian policy framework, evaluates needs, and recommends strategies for implementation.

The **Bicycle Master Plan** also details policies from the General Plan but differs slightly in that it focuses on identifying the long-range vision for the bicycle transportation network. The Class I off-street trail system envisioned in the Bicycle Master Plan is intended to be available for use by pedestrians and persons with disabilities.

The **Americans with Disabilities Act (ADA) Transition Plan** develops policies and practices for implementing physical pedestrian improvements within the public rights-of-way. The goals of the Transition Plan are to optimize the pedestrian experience, to provide safe and usable pedestrian facilities for all pedestrians, and to assure compliance with all federal, state, and local regulations and standards. The ADA Transition Plan was approved by the City Council in 2005 prior to the completion of the General Plan. An update of the ADA Transition Plan is anticipated.

Through the Pedestrian Improvement Program, residents can report any sidewalk locations that may need repair.



PROGRAMS AND PROJECTS

The **Pedestrian Improvement Program** supports the development of the Pedestrian Master Plan and supports the annual sidewalk repair projects. California Streets and Highways Code Section 5610–5618 Maintenance of Sidewalk states that sidewalk repair is the responsibility of the adjacent property owner. However, the City Council has directed staff to help residential property owners with these repairs, and as a result, annual sidewalk repair projects have improved nearly 130 locations since 2003.

This program also provides planning support for pedestrian elements that are built with other Public Works projects and supports the development of grant applications for pedestrian improvements. A successful application for the State Safe Routes to School program resulted in a \$675K grant that will build a new sidewalk along Folsom Boulevard between the Cordova Town Center Light Rail Station and Kinney High School.

The **Bikeway Improvement Program** supports the development of the Bicycle Master Plan, ongoing bicycle programming efforts, and some improvements to the Class II (on-street) bicycle system. The program has created a vision for an extensive Class I bicycle system in new areas of the City and has expanded plans for the trail system in existing neighborhoods. A small number of on-street bicycle lane striping projects and roadway bike route signage projects have been implemented under this program.

The **Neighborhood Traffic Management Program** was conceived and adopted prior to the completion of the City’s General Plan. The purpose of traffic calming is to reduce the negative effects of motor vehicle use, alter driver behavior, and improve conditions for non-motorized street users—pedestrians, cyclists, and people with disabilities. The Neighborhood Traffic Management Program has supported the development of four neighborhood area improvement projects and provided for planning, committee meetings, citizen outreach, and the development of plans and specifications for these projects.

The **Elderly and Disabled Access Improvement Program** is designed to provide planning support and some fiscal support for other Public Works projects that can be expanded to improve access for seniors and persons with disabilities. This program will also support the update of the ADA Transition Plan.

20 TONS IN 2010

It is well known that healthy people invigorate our community. Improved health can reduce health-care costs and reduce absenteeism in the workplace. In the year 2010, the Mayor of Rancho Cordova created the Great Health Challenge that set a collective citywide weight loss goal of 20 tons in the year 2010. Monthly walks with the Mayor were among many activities designed to engage local residents and businesses to create increased awareness of good nutritional habits and healthy lifestyles. Over 1,250 participants registered and lost an average of 15 pounds each.



COMMUNITY OUTREACH RESULTS

The outreach element of the Pedestrian Master Plan is built on three components: a legacy outreach process initiated by Sacramento County just prior to cityhood, several outreach meetings as part of Rancho Cordova’s plan development process, and staff targeted outreach to schools and senior centers in the City. Sacramento County’s outreach process gathered key public concerns that are integrated into concerns that were identified in the current master plan outreach process. The Pedestrian Master Plan focuses on specific goals, accomplishments, and continuing needs at specific Rancho Cordova schools and senior centers.

LEGACY OUTREACH BY SACRAMENTO COUNTY

The County of Sacramento pursued extensive outreach as part of its Pedestrian Master Plan process that occurred prior to Rancho Cordova’s incorporation in 2003. Citizen advisory groups were formed along with technical advisory groups that included agency and advocacy interests. The County also invited input through web access via electronic newsletters and a listserv.

Feedback was received on sidewalk gaps, or locations where sidewalks are not provided, signal timing, short walk-intervals, the need for improved walking routes around schools, maintenance of sidewalks, and the need to reduce jaywalking across Folsom Boulevard.

Street Crossing Concerns

- High-speed cars
- Dual turn lanes
- Lack of marked crosswalks on all legs of intersections
- Lack of safety islands or median refuges
- Right turn on red conflicts
- Need for midblock signals at high pedestrian traffic locations

Other Desires and Concerns

- Need to separate sidewalks from auto travel lanes
- Need to eliminate obstructions in sidewalks (e.g., power poles and signs)
- Need wider sidewalks
- Need ancillary amenities, rest areas (benches)
- Speeding on Coloma Road



CITY OF RANCHO CORDOVA • PEDESTRIAN MASTER PLAN

- Streets too wide to get across
- Lots of debris, need better maintenance
- No places to cross safely on Olson Drive
- Need better pedestrian facilities around the Post Office on Progress Court and at Coloma Road
- Sunrise Boulevard is extremely unfriendly to pedestrians

RANCHO CORDOVA PEDESTRIAN MASTER PLAN OUTREACH

Several Technical Advisory Committee meetings and an initial Master Plan Open House were held in the spring and summer of 2009 to identify citizen concerns and needs.

There were approximately 35 attendees at the open house held June 2, 2009. The majority of attendees were residents of Rancho Cordova, with a few City workers (living outside the City) and a consortium of agency employees and advocacy representatives.

The workshop provided an opportunity for participants to define the pedestrian environment in Rancho Cordova. Attendees were asked where they live, work, and play and were asked for information on how they chose walking trips.

Why do you walk?

Transportation

- School – 0 (there were no school-aged attendees)
- Work – 4
- Shopping, etc. – 14
- Other – 3

Recreation

- Alone – 9
- With family or friends – 12

Fitness & Conditioning

- 12



CHAPTER 2 • EXISTING CONDITIONS

How often do you walk?

- Daily – 15
- 4X week – 2
- 2X week – 2
- 1X week – 1
- 1X every 6 months – 2

What prevents you from walking more often?

- Not enough time – 9
- Too much traffic – 2
- Not enough safe routes – 8
- Lack of safe crossings – 4
- Lack of signage – 1
- Other – 4
- Lack of shade – 1

The open house also requested specific issues related to making walking trips. Primary concerns that surfaced included:

- A need for vertical curbs on the edge of roads as opposed to rolled curbs – It was recognized that a vertical curb provides a positive barrier between pedestrian traffic and automobile traffic. A vertical curb can help to deflect an errant automobile, increasing pedestrian safety and clearly identifying the border between pedestrian and automobile travel paths.
- A concern about conflicting uses on a multi-use path such as the American River Parkway Trail System – Space is at a premium on this highly traveled facility. The following Rules of Trail Courtesy were identified to help guide users:
 - Users on foot should stay on the left shoulder.
 - Bike riders and inline skaters should stay on the asphalt path, right of the yellow centerline.
 - A 15 mph speed limit is enforced.
 - Passing should only be performed on the left, with a verbal warning.
 - Horses are not allowed on the paved trail surface except at trail crossings and bridges. Yield to horses whenever they are encountered.

Workshop participants expressed concern about the need to share multi-use paths with various user groups.



- Some concerns expressed included allowing pedestrians and runners to use a paved path, and provision of a separated walking/running path that would protect pedestrians from cyclists that ride too fast.
- A concern about the difficulty of crossing the Zinfandel Drive interchange over Highway 50 for both bicycles and pedestrians – The interchange is designed to maximize automobile throughput and seems to consider non-auto travel as an ancillary service. Free-flow ramps create difficult pedestrian crossings, and the vertical crest profile of the Zinfandel Drive bridge over the highway reduces sight distance for pedestrians who are crossing ramps. The two-lane loop entrance to westbound Highway 50 is particularly challenging.
- A desire for more walking paths in community parks.
- A concern about paths being an afterthought in the development process – There should be an attempt to better integrate trail planning in the development of new neighborhoods.
- Need a push button to cross Coloma when traveling northbound on Bridlewood – *As a note, the City has recently improved Coloma Road in the vicinity of Bridlewood Drive and upgraded signals, adding bicycle detection and upgrading walk-light request infrastructure. The intersection is also striped for crosswalks on all legs of the intersection.*
- No sidewalks on White Rock Road east of Sunrise Boulevard.
- A need for trail connections to roads outside the Villages of Zinfandel and trail connections to the Folsom South Canal – *Note: These connections are being proposed as part of the Bicycle Master Plan Trails Element.*

School administrators are concerned about automobile circulation during drop-off and pick-up times.

TARGETED OUTREACH

According to the 1995 Nationwide Personal Transportation Survey (NPTS), children between the ages of 5 and 15 walk far more than people in other age groups. The NPTS also identifies senior and retired citizens as more likely to walk than age groups that are currently in the workforce.

Targeted outreach is intended to describe a set of working relationships between City staff and school administrators and senior care centers. The following sections describe the interactions that are currently taking place and have been developing since cityhood.



Summary of Efforts at School Sites

City of Rancho Cordova staff worked with school administrators on existing issues, challenges, and opportunities at Rancho Cordova's school sites. The results of this targeted outreach are presented below.

In general, school administrators are looking for more “high profile” pedestrian crossings of roads adjacent to schools along with signing that alerts drivers to student activity. Administrators are supportive of traffic calming efforts, and they are concerned about auto circulation during drop-off and pick-up times. Specific improvements and continuing issues at school sites are listed below.

- **Sunrise Elementary School, 11821 Cobble Brook Drive (Anatolia)** – Signage and striping provided at intersections; school is using temporary traffic control devices (cones) during pick-up and drop-off times.
- **A. M. Winn Elementary School, 3351 Explorer Drive** – High visibility crosswalk striping provided in several locations; built a lighted crosswalk on Explorer Drive; may be additional opportunities for crosswalk striping.
- **Abraham Lincoln Elementary School, 3324 Glenmoor Drive** – High visibility crosswalk striping provided.
- **Cordova Gardens Elementary K–6, 2400 Dawes Street** – Some high visibility crosswalk striping provided; 2010 Traffic Calming Project to traffic along Dawes Street and Rinda Drive.
- **Cordova Lane Elementary K–5, 2460 Cordova Lane** – High visibility crosswalks provided on Zinfandel Drive; the Neighborhood Traffic Management Program proposes a traffic circle at Cordova Lane and Zinfandel Drive. *Note: This school is planned for closure.*
- **Cordova Meadows Elementary K–5, 2550 La Loma Drive** – Some high visibility crosswalks provided; may need to increase visibility of crosswalks in some locations; the 2008 Traffic Calming Project provided speed humps and a raised crosswalk along La Loma Drive.
- **Cordova Villa Elementary K–5, 10359 S. White Rock Road** – Traffic calming along White Rock Road was installed prior to cityhood; discussing need for a high visibility lighted crosswalk; opportunities for improved crosswalk striping and some sidewalk repair (the school has recently rehabilitated and improved site work and on-site circulation).
- **Navigator Elementary K–5, 10679 Bear Hollow Drive** – High visibility striping provided; opportunity for additional bike lane striping; completed work with the Goddard School to correct speed reduction signing; interest in building a temporary trail within a privately owned parcel that would provide walking access to the Mather Community Campus in the North Mather area.



CITY OF RANCHO CORDOVA • PEDESTRIAN MASTER PLAN

- **Peter J. Shields Elementary – K–5, 10434 Georgetown Drive** – 2008 Traffic Calming Project has slowed traffic along Georgetown Drive; may be an opportunity to update high visibility striping; there also is a need for sidewalk repair.
- **Rancho Cordova Elementary K–6, 2562 Chassella Way** – There are missing sections of sidewalk that need to be completed.
- **Riverview Elementary K-6, 10700 Ambassador Drive** – ADA ramps provided, along with high visibility striping; there is an interest in raised crosswalks. *Note: This school is planned for closure.*
- **White Rock Elementary K–6, 10487 White Rock Road** – High visibility crosswalk striping provided with in-road warning lights at the White Rock Road crosswalk; a new sidewalk has been installed at White Rock Park across from the school, with ADA ramps on White Rock Road and Evadna Drive; the school is also discussing opportunities for bulb-outs and has built a bulb-out along White Rock Park at the Evadna Drive intersection (the school has recently rehabilitated and improved site work and on-site circulation).
- **Williamson Elementary K–5, 2275 Benita Drive** – High visibility crosswalk striping provided; also planning a raised crosswalk along Benita Drive.
- **Mills Middle School 6–8, 10439 Coloma Road** – Concerns about speeding along Chase Drive; opportunities to improve striping and crosswalks; a midblock pedestrians signal is provided across Coloma Road at the east edge of the site; 2010 Traffic Calming Project to provide electronic speed feedback signs along Chase Drive.
- **Mitchell Middle School 6–8, 2100 Zinfandel Drive** – New ADA ramps and high visibility crosswalks on Zinfandel Drive.
- **Cordova High School 9–12, 2239 Chase Drive** – Concerns about speeding along Chase Drive; opportunities to improve striping and crosswalks, 2010 Traffic Calming Project to provide electronic speed feedback signs along Chase Drive.
- **Walnutwood High School/Adult Education, 10850 Gadsten Way** – High visibility crosswalks provided; concerns about speeding on Gadsten Way.
- **Kinney High School (Continuing Education), 2710 Kilgore Road** – High visibility crosswalk along Kilgore Road; the City has obtained a Safe Routes to School grant to provide a sidewalk along the south side of Folsom Boulevard to the Cordova Town Center Light Rail Station.



Senior Care Centers

Cordova Recreation and Park District Senior Center, 3480 Routier Road

The Cordova Recreation and Park District (CRPD) manages this care center that is located within the Lincoln Village Community Park. The center provides activities for seniors including fitness activities, sports, and bird watching. An after-school program that targets schoolchildren is also provided for people with disabilities. Most of the population served by this center arrives by car or shuttle. Sacramento County provides a couple of shuttles that are used for pick-up and drop-off. There are very few walkers or public transit users.

CRPD is working with the Rancho Cordova Police Department to create a safer environment for the center. CRPD would like to attract more neighborhood utilization from local residents. Nighttime lighting is a challenge both on site and along adjacent roadways. It is recognized that additional lighting could be controversial for some residents.

During larger events, parking becomes constrained. The center utilizes a County-owned parking lot across Routier Road, which results in some instances of jaywalking. There are protected crosswalks at either end of the site, but that requires walkers to go about 1,000 feet in either direction along Routier Road. A Regional Transit Bus Stop is located directly across Routier Road from the center building.

The recent Routier Road Pavement Rehabilitation Project will calm vehicular traffic through pavement striping and will eliminate tripping hazards along sidewalks. Tripping hazards are a significant concern for senior citizens. The project will also provide additional width along sidewalks that have obstructions.

Rancho Cordova Adult Day Health Care Center, 10086 Mills Station Road

This privately run facility provides daily services to approximately 140 clients throughout the Sacramento area. Services include daily lunches, nursing, social work, exercise, massage, and occupational therapy. The majority of clients are brought to the center on a privately owned fleet of 10 shuttles. The center is located a block away from the Mather Mills Regional Transit Light Rail Station, and some clients arrive on scooters and in wheelchairs.

Clients face challenges such as a lack of ADA access ramps at intersections and overgrown vegetation along walkways that push wheelchair users toward the street. The center also has a contract with the Veterans Administration Hospital across Highway 50, resulting in challenges for travelers who prefer to walk and do not ride the shuttles.

Care Centers in Private Residences

Approximately eleven homes in the City are licensed to provide senior care services. These businesses provide care for a small number of senior residents and may provide permanent housing.



WORKSHOP: JULY 2010

Workshop Summary and Key Results

The purpose of this workshop was to gather input from the Council and members of the public to establish a clear vision for the Rancho Cordova Bicycle and Pedestrian Master Plans. Three Council members were in attendance, in addition to numerous members of the public and other key stakeholders from local agencies, advocacy organizations and the development community.

The workshop began with a Staff introduction to the project and an overview of the meeting's purpose. Guest speakers from SABA (Owen Howlett), WalkSacramento (Eric Fredericks) and Design Sacramento 4 Health (Dr. Charlene Hauser) were invited to present their vision for walking and bicycling in Rancho Cordova. Following the speakers' presentation, Staff provided a more detailed look at the contents of the Plans, including the key recommendations.

Following the Staff presentation, an open discussion among Council members and workshop attendees was moderated by the Mayor. The primary themes that emerged from the discussion are identified below.

Funding

- Grant opportunities
- Explore funding measures other cities have used
- SACOG for “complete streets” funding
- Safe Routes to School

The issue of funding was addressed as a priority for many of the meeting participants. In order to draft a realistic plan, different funding options like grant opportunities and other creative funding sources must be considered. Some participants also suggested exploring funding options that other cities in the area have used to implement similar plans. Additional funding sources to consider included SACOG for “complete streets” funding as well as Safe Routes to School.

Education

- Focus on public health issues
- Quality of life
- Work towards “bicycle friendly” designation from the League of American Cyclists
- Participation in Safe Routes to School



CHAPTER 2 • EXISTING CONDITIONS

Participants also expressed interest in public education. One suggestion included focusing education on public health issues, turning Rancho Cordova into a community focused on fitness. City designations like becoming a “bicycle friendly” community by the League of American Cyclists emerged as an important consideration as well as participation in the Safe Routes to School program. Council members and some participants felt this sort of designation and focus on quality of life issues could be an effective economic development tool for the City.

Bicycle & Pedestrian Master Plan Goals

- Safety
- Connectivity issues
- “Complete streets” approach
- Land use, density and services
- Use of good signage and sharrows
- River and trail access

Bicycle and pedestrian safety was discussed as an explicit goal of the plan with many suggestions for accomplishing safety goals. Looking at the existing connectivity issues within the city and perhaps using the “complete streets” model to address connectivity was one approach to be considered. Also, current land use, density and location of services need to be evaluated for bicycle and pedestrian access.

Some safety issues can be addressed using good signage and sharrows. There was also some discussion about providing access to the river and connecting existing parks throughout Rancho Cordova.

Photo Contest

The workshop concluded with a Master Plan cover photograph selection contest. Dave Cassel’s winning photograph “Biker on the Sunrise Foot Bridge at Sunset” will be placed on the Cover of the Bicycle Plan. The City would also like to thank the following for their photo submittals.

James Begg – Franklin Templeton Bicycle Commuters

JoAnna Bueno Williams and Ryan Lundquist – Project 680 Bike Ride

Jeff Beiswenger – Bridge Bike Rack

Travis Evans – American River Parkway

Mark Thomas – American River Parkway





Chapter 3:
PEDESTRIAN
POLICY FRAMEWORK





3

CHAPTER 3

Pedestrian Policy Framework

Rancho Cordova's existing planning documents provide a strong foundation for the development of a pedestrian network and support facilities. The 2006 General Plan set the precedent for pedestrian policy, with goals, policies, and actions outlining the City's dedication to the creation of an extensive trail network and well-maintained facilities.

As an implementing mechanism of the General Plan, this Pedestrian Master Plan enhances the existing policy framework, working hand in hand with the existing policies in the General Plan. The new goals, policies, and actions set forth in this chapter help to complete the existing policy framework by providing more detailed direction with regard to implementation, funding, partnerships, mode share targets, and Rancho Cordova's role as a walkable destination.

EXISTING GENERAL PLAN GOALS

The 2006 General Plan contains numerous goals, policies, and actions with bearing on the City's pedestrian facilities. The most relevant goals from the General Plan Elements are repeated below.

FROM THE CIRCULATION ELEMENT

Goal C.2: Establish an extensive, complete, smooth, interconnected, and continuous pedestrian and bicycle network that is a safe and attractive option for local or regional trips or recreation and that connects to the City's neighborhoods, parks and schools, employment areas, and retail centers.

Goal C.6: Provide a circulation system that is properly maintained and maximizes safety for all users.

FROM THE OPEN SPACE AND TRAILS ELEMENT

Goal OSPT.3: Create a system of pedestrian and bicycle trails that maximize usage while providing places for walking and bicycling without conflicts with motor vehicles.



CITY OF RANCHO CORDOVA • PEDESTRIAN MASTER PLAN

Goal OSPT.4: Encourage public use of all trails and open space and promote public input in creating and maintaining these resources.

FROM THE LAND USE ELEMENT

Goal LU.2: Establish growth patterns based on smart growth principles and the City building blocks concept.

FROM THE URBAN DESIGN ELEMENT

Goal UD.1: Development in keeping with the building block concepts of neighborhoods, villages, and districts.

FROM THE SAFETY ELEMENT

Goal S.4: Safe railroad crossings for pedestrians, bicyclists, or motorists.

Goal S.1: Establish Rancho Cordova as a safe community and environment for all persons.

FROM THE AIR QUALITY ELEMENT

Goal AQ.2: Support land use patterns and densities that lessen air quality impacts.

Goal AQ.3: Support multiple forms of transportation and a circulation system design that reduces vehicle trips and emissions.

PEDESTRIAN MASTER PLAN GOALS, POLICIES, AND ACTIONS

With a sound policy framework provided by the General Plan, the policy direction set forth in this Pedestrian Master Plan intends to fill existing gaps in Rancho Cordova's policy language. In some instances, policies contained in this Plan supersede General Plan policies that have become outdated as the City has successfully implemented facilities and programs.

Goal 1 Improve the pedestrian network to increase pedestrian activity in Rancho Cordova.

- 1.1 The City shall expand the sidewalk network to increase walking for transportation and recreation.
 - 1.1.1 Use a systematic approach to prioritize and allocate resources to identify and improve pathways in disrepair.
 - 1.1.2 Review all new or redevelopment projects for consistency with the goals, policies, and actions of the Pedestrian Master Plan.



CHAPTER 3 • PEDESTRIAN POLICY FRAMEWORK

- 1.2 The City shall work to eliminate Highway 50 as a barrier to pedestrian travel.
- 1.2.1 Identify opportunities to improve or add pedestrian crossings of Highway 50.
- 1.2.2 Work with Caltrans to implement projects identified in this Pedestrian Master Plan that enhance pedestrian safety and connectivity across the Highway 50 corridor.
- 1.3 The City shall enhance pedestrian nodes and corridors.
- 1.3.1 Identify the top priority node and corridor improvements and consider greatest need and critical mass.
- 1.3.2 Tailor corridor improvements according to neighborhood character and public input.
- 1.4 The City shall continue to assist neighborhoods that desire to improve pedestrian access to, from, and within their neighborhood.
- 1.4.1 Continue to develop and implement Neighborhood Circulation Plans.
- 1.4.2 Develop flexible and accessible walkway options for neighborhoods to reflect their character and physical conditions.
- 1.4.3 Protect, maintain, and expand residential connections including easements and historically used pedestrian shortcuts that reduce walking distances and encourage walking.
- 1.5 The City shall work with transit providers to develop high quality and pedestrian-accessible transit stops as well as connections to them.
- 1.6 Improve and expand the multi-use trail system to increase walking for transportation and recreation.

*Identify opportunities
to improve or add
pedestrian crossings of
Highway 50.*



Goal 2 Provide universally safe and equal access.

- 2.1 The City shall improve pedestrian access for the disabled community.
 - 2.1.1 Continue to implement the ADA Transition Plan.
 - 2.1.2 Continue to retrofit street corners, crossings, and transit stops that do not meet current accessibility standards.
 - 2.1.3 Use regulation and incentives to require or encourage accessibility upgrades for private businesses.
 - 2.1.4 Encourage businesses to exceed the minimum standards set by the ADA “readily achievable barrier removal” requirement.

- 2.2 The City shall improve pedestrian safety and comfort at intersections.
 - 2.2.1 Annually review pedestrian complaints and crashes to implement ongoing improvements at intersections.
 - 2.2.2 Adjust traffic signal operations as needs are identified.
 - 2.2.3 At high safety risk intersections, consider “smart” signals to improve intersection safety and convenience for pedestrians, and pedestrian/bicycle-activated signals that allow bikes and pedestrians to cross busy streets without inviting traffic onto cross streets.
 - 2.2.4 Identify locations where pedestrian signals need to be re-programmed to allow for longer pedestrian phases, accommodating slower walkers.
 - 2.2.5 Consider expanding locations for pedestrian crosswalk in-road warning lights (in-pavement flashing crosswalk lights) in the pavement at intersections with severe or higher than average pedestrian collision rates.
 - 2.2.6 Enforce jaywalking regulations on main arterials.
 - 2.2.7 Encourage the creation of accessible pedestrian medians or islands in wide streets where people have to cross more than two lanes.
 - 2.2.8 Enforce pedestrian right-of-way laws.



CHAPTER 3 • PEDESTRIAN POLICY FRAMEWORK

Goal 3 Establish and enhance routes to school that will enable and encourage more students to safely walk to school.

- 3.1 The City shall continue to the work of the Pedestrian Improvement Program.
 - 3.1.1 Continue to design, seek funding for, and implement Safe Routes to School projects.
 - 3.1.2 Provide coordination between local organizations, schools, the community, parents, neighborhoods, and City departments.
 - 3.1.3 Implement citywide and school-specific education and encouragement programs.
 - 3.1.4 Implement enforcement, operational, and engineering measures as feasible on identified routes.
- 3.2 Consider working with local schools or community groups to develop and maintain maps that identify the most appropriate routes for children to walk to school.

Encourage people to walk through education and awareness efforts.

Goal 4 Develop pedestrian-supportive encouragement and enforcement programs.

- 4.1 Support education and enforcement programs to encourage carpooling and alternatives to single-occupant automobile use, reduce speeding, and increase pedestrian, bicyclist, and automobile safety.
 - 4.1.1 Develop a program that rewards households, block groups, or neighborhood organizations that can document their reduction in automobile use.
 - 4.1.2 Encourage hotels, motels, and other visitor destinations to provide visitors with information on pedestrian circulation, public transportation, and bicycle services and facilities.
 - 4.1.3 Encourage people to walk through education and awareness efforts.
 - 4.1.4 Enforce laws that protect pedestrians.

Enforce laws that protect pedestrians.



Goal 5 Pursue innovative funding sources and partnership opportunities to enhance pedestrian facilities, and provide education and encouragement opportunities.

- 5.1 Pursue a diverse array of funding sources for pedestrian improvements, including federal, state, and local sources, development agreements, and private funding.
- 5.2 Coordinate with community members and local and regional groups to increase stewardship of pedestrian facilities in terms of regular maintenance.
- 5.3 Pursue nontraditional funding sources for pedestrian improvement projects, such as climate change, air quality, and other emerging sources.
- 5.4 Coordinate the installation and maintenance of pedestrian improvements with other major roadway improvement projects.
- 5.5 When feasible, coordinate pedestrian infrastructure projects with other open space and conservation projects, such as streambank restoration, native habitat restoration, utility improvements, and flood control projects.
- 5.6 Where the pedestrian network intersects jurisdictional boundaries, partner with neighboring jurisdictions to share the financial obligation of pedestrian infrastructure projects.

PEDESTRIAN STANDARDS

The City of Rancho Cordova has an interest to ensure that its goals, policies, and values are incorporated into existing neighborhood improvements and into new transportation infrastructure in developing areas. These goals and values are promoted and ensured through the development of improvement standards. In general, the City of Rancho Cordova has incorporated the vast database of County of Sacramento Standards and refers to them for most new construction. However, as the City refines its objectives, new or updated standards need to be developed. Both the Neighborhood Traffic Management Program and the Americans with Disabilities Act Transition Plan provide new or updated standards. The Bicycle Master Plan and Pedestrian Master Plan will also incorporate new standards that improve access and desirability for non-auto transportation travel.

COMPLETE STREETS

A coalition of local and regional jurisdictions in the Sacramento area formed the Sacramento Transportation & Air Quality Collaborative and published a best practices report on Complete Streets in October of 2005. Complete streets are those that adequately provide for all roadway users, including bicyclists, pedestrians, transit riders, and motorists, to the extent appropriate to the function and context of the street. The City of



CHAPTER 3 • PEDESTRIAN POLICY FRAMEWORK

Rancho Cordova responded by updating the entire range of standard street and arterial roadway cross sections in 2006, formally adopting the collaborative's goals for the region. These standard drawings are provided in Appendix A.

Additional improvement standard updates include:

PEDESTRIAN REFUGE

The purpose of this standard is to help pedestrians cross wide multilane roadways by allowing a safe place to stand in the median of the roadway. The intimidation of getting across eight to ten lanes of car traffic can be reduced if the pedestrian can focus on one direction of traffic at a time and cross half as many lanes.

PORK CHOP ISLAND

The concept of this standard is similar to the pedestrian refuge. It reduces crossing distance at major roadway intersections. The pork chop island is a place of refuge that is located between the right-turning traffic lanes and the through lanes.





Chapter 4:
NEEDS ASSESSMENT





4

CHAPTER 4

Needs Assessment

The demand for pedestrian infrastructure has grown as Rancho Cordova's population has increased. Trends show that pedestrians are more likely to be youth and seniors, age groups for whom driving may not be a feasible transportation mode. This chapter outlines walking trends and pedestrian demand in Rancho Cordova, with a particular focus on the needs of youth and seniors.

PEDESTRIAN DEMAND

Pedestrian activity frequently occurs in the vicinity of destinations like schools, senior centers, shopping centers, and office buildings, where parking may be limited and walking is a convenient form of transportation. Land uses that act as pedestrian trip generators, such as schools, parks, commercial areas, and employment centers, are shown on the Figure 4.1: Pedestrian Generators.

Senior Care Centers – For various reasons, the senior/retired age group has one of the highest percentages of walkers. Many seniors choose not to drive and instead prefer the healthier, more scenic option of walking. One key location where walking seniors can be found in Rancho Cordova is at the Senior Center on Routier Road where many activities are held for seniors.

Transit Stations – These transportation hubs attract many pedestrians, especially commuters, who either choose to walk or who have other modes of transportation unavailable to them. This makes it possible for commuters to travel along the Highway 50 corridor, connecting them to popular destinations such as the City of Sacramento or the City of Folsom. Also, it connects commuters outside of Rancho Cordova to the many employers in the City of Rancho Cordova.

Regional Transit Routes – Several Regional Transit (RT) bus routes provide City circulation connecting to the RT Light Rail Gold Line stations along Folsom Boulevard. Six of these routes connect to the heavily utilized Mather Field/Mills Station and also provide connections outside the City to the Sunrise Mall and the Rosemont neighborhoods.



CITY OF RANCHO CORDOVA • PEDESTRIAN MASTER PLAN

The Rancho CordoVan – The Rancho CordoVan was recently launched to further promote pedestrian activity. This valuable resource connects the business parks to the light rail stations.

Highway 50 Crossings – These connections make pedestrian travel possible across barriers that would be daunting otherwise. These crossings connect the residences, businesses, and parks on the south side of Highway 50 with those on the north side.















American River Parkway and Parkway Access Points – The American River Parkway attracts thousands of pedestrians and bicyclists every year. It is a designated Class I trail that runs along the American River from Folsom to Sacramento. The parkway is a great way to commute or enjoy a jog or walk. Access to this valuable resource is very important. Pedestrians should be able to access the trail from multiple locations in order to promote the trail's use.

Schools – Most school-aged children are unable to drive to school, which creates a huge opportunity for pedestrian activity. Walking to school can have a tremendous positive impact on the student's health, well-being, and scholastic performance.

Retail/Commercial Centers – These centers attract many pedestrians running errands or shopping for leisure. Since shopping itself is done primarily by walking, many pedestrians walk to and from various shops and between shopping centers. It is advantageous to make these centers accessible to residential neighborhoods in an effort to eliminate automotive trips if possible.

Parks and Recreation Areas – These areas naturally attract the outgoing person who also tends to enjoy walking when possible. These areas also attract many school-aged pedestrians who are unable to drive. It is important to promote the use of parks and recreation areas to encourage healthy habits and activities.



- S SENIOR CARE CENTERS
-  TRANSIT STATIONS
-  REGIONAL TRANSIT ROUTES
-  REGIONAL TRANSIT STOPS
-  RANCHO CORDOVA ROUTE
-  RANCHO CORDOVA STOPS
-  CLASS I BIKE PATH / WALKWAY
-  HIGHWAY 50 CROSSINGS
-  EXISTING OVERCROSSING
-  EXISTING UNDERCROSSING
-  INTERCHANGE WITH PEDESTRIAN ACCESS
- PARKWAY ACCESS POINTS**
-  PAVED ACCESS
-  PEDESTRIAN ONLY
-  SCHOOLS
-  RETAIL/COMMERCIAL CENTERS
-  PARKS & REC AREAS

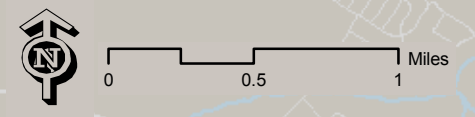
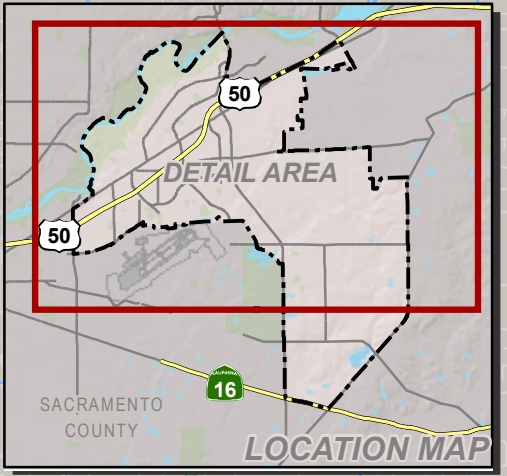
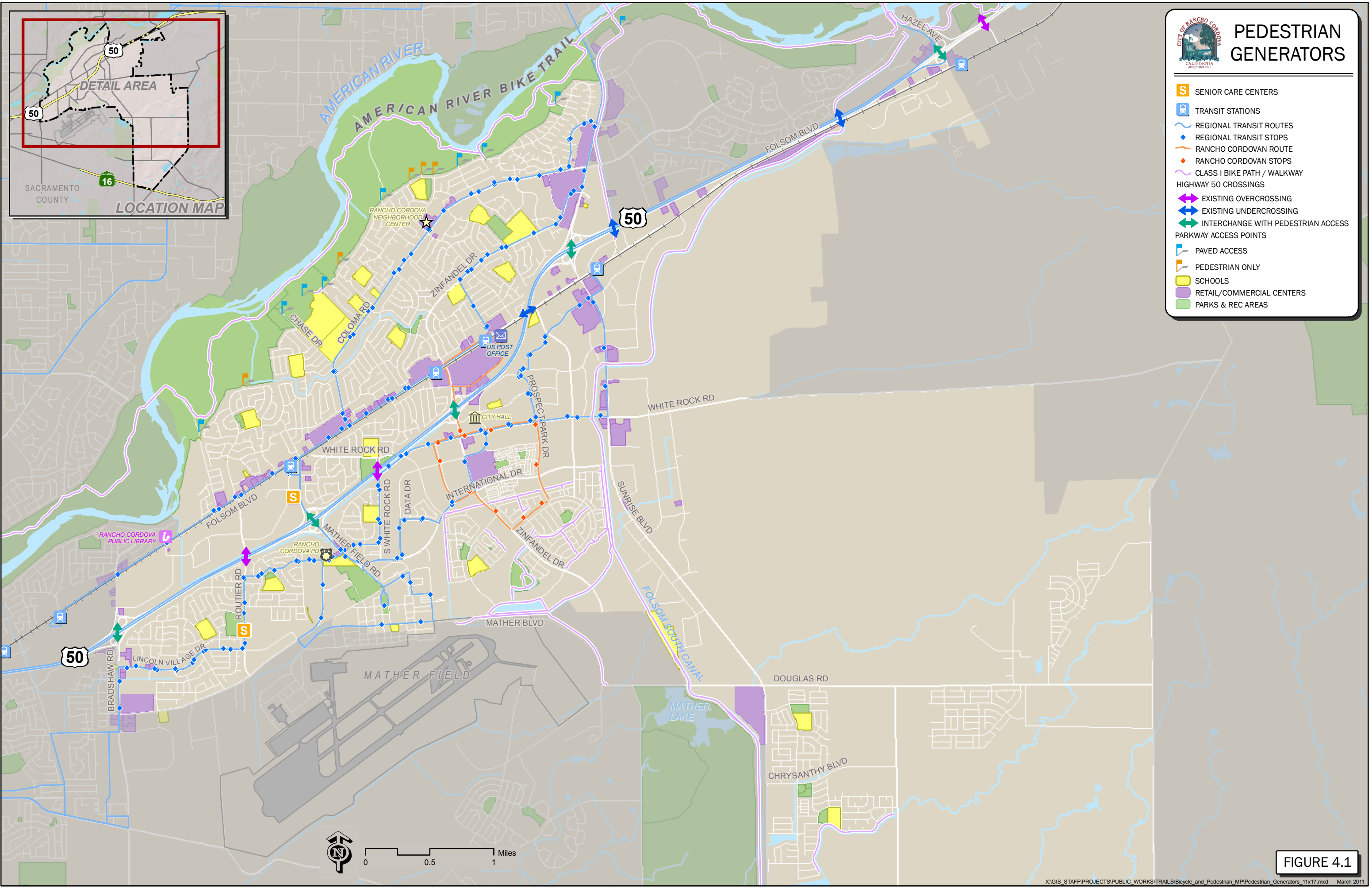

FIGURE 4.1

2009 PEDESTRIAN SURVEYS

As part of the assessment of pedestrian demand and through participation with the National Bicycle and Pedestrian Documentation Project, the City monitored several high volume pedestrian activity locations during September 2009. Through this effort, a general evaluation was made about who is using the existing facilities, where they are coming from, and where they are going. The analysis of survey results shows how current facilities may be improved and how pedestrian facilities in other areas of the City may be promoted further. Seven locations were evaluated near schools, light rail stations, and freeway interchanges (see Appendix B for data sheets). The following are summaries of the results, organized by location. Also see Figure 4.2.

Zinfandel Light Rail Station

Pedestrian activity was spread out fairly evenly in the morning, with an hourly peak at 7:15–8:15 AM yielding 34 pedestrians and 13 bicyclists. The evening peak period occurred at 3:30–4:30 PM, with 81 pedestrians, 9 bicyclists, and 6 jaywalkers. Many strollers were observed at this location. Ten jaywalkers were observed in the evening peak.

Coloma Road at Chase Drive

This intersection is a key access point for Mills Middle School and Cordova High School. In the morning between 7:15 AM and 9:15 AM, there were a total of 299 pedestrians and 79 bicyclists. Many of the pedestrians were school-aged children. In the evening between 2:30 PM and 4:30 PM, there were 355 pedestrians and 62 bicyclists. The students in the evening came from two separate directions with two separate peak periods, corresponding to dismissal times at the high school and the junior high school. In both the morning and evening, many of the middle-school-aged children walked through a field adjacent to Coloma Road as a shortcut.

Zinfandel Road at Benita Drive

This intersection is a key access point for Mitchell Middle School and Williamson Elementary School. In the morning between 7:15 AM and 9:15 AM, there were 86 pedestrians and 21 bicyclists. In the evening from 1:45 PM and 4:00 PM, there were 131 pedestrians and 21 bicyclists. However, the volume was not as high as expected. There were not many students coming or going from the direction of the elementary school at this intersection. As a result, a follow-up survey was performed at Benita Drive and Segovia Way. At the beginning of the survey, the streets were lined with cars ready to pick up the students. Vehicles appeared to be the primary mode of travel for the students leaving Williamson Elementary School. However, several pedestrians were observed. Most pedestrians were observed to travel north on Benita Drive. Some traveled east on Segovia Way, and some crossed Benita Drive illegally at midblock and traveled west on Pinturo Way. Very few traveled south toward Zinfandel Drive where the previous survey had been performed. Over a 30-minute period, there were 93 pedestrians and 1 bicyclist.





2009 PEDESTRIAN SURVEY LOCATIONS

- SURVEY LOCATION
- TRANSIT STATIONS
- REGIONAL TRANSIT ROUTES
- RANCHO CORDOVAN ROUTE
- SCHOOLS
- RETAIL/COMMERCIAL CENTERS
- PARKS & REC AREAS
- RANCHO CORDOVA CITY LIMITS

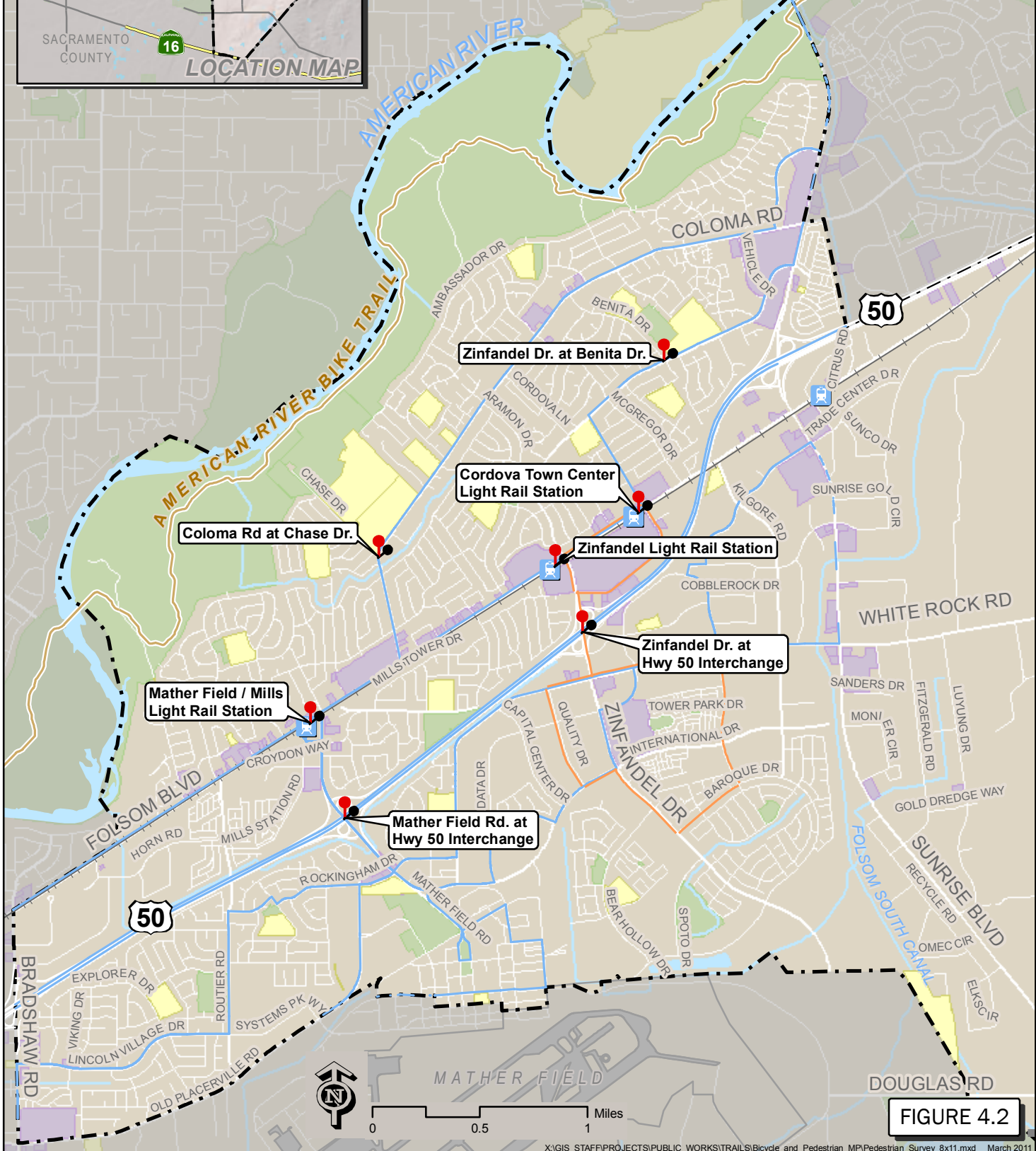
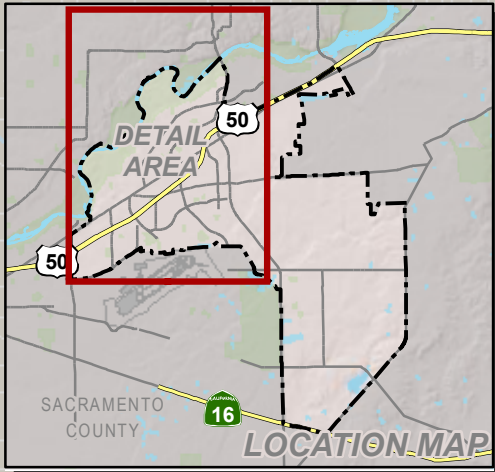

FIGURE 4.2

Cordova Town Center Light Rail Station

At this location, there was a fairly steady moderate volume from 7:30 AM to 9:00 AM, with a peak at 8:00 AM–9:00 AM yielding 81 pedestrians and 5 bicyclists. Between the hours of 6:45 AM and 9:00 AM, 30 people were observed to jaywalk. Activity in the evening was moderate between the hours of 3:45 PM and 5:00 PM, with a peak period of 3:30 PM–4:30 PM yielding 62 pedestrians and 21 bicyclists. There were 43 jaywalkers observed between the hours of 3:30 PM and 6:00 PM.

Mather Field/Mills Light Rail Station

At this light rail station, the peak hour occurred between 7:15 AM and 8:15 AM, with 54 pedestrians and 18 bicyclists. Many people were carrying bags or wearing backpacks. Most people came from the parking lot and bus stop directly south of the light rail station. The majority of pedestrians who disembark the train got on the bus. In the evening, the peak period is from 4:15 PM to 5:15 PM, with 108 pedestrians and 17 bicyclists. The majority of people are coming from the parking lot. There were many people with strollers or wheelchairs. There were fewer jaywalkers than at the Zinfandel Light Rail Station, likely due to the pedestrian crossing signal that is provided.

Mather Field Road at Highway 50 Interchange

The morning peak period occurred between 8:00 AM and 9:00 AM, with 13 pedestrians and 8 bicyclists. Between 6:45 AM and 9:00 AM, 27 pedestrians and 16 bicyclists were observed. Two people jaywalked and one person walked along the train tracks to avoid the Mather Field interchange. In the evening, the peak period occurred between 3:45 PM and 4:45 PM, with 13 pedestrians and 10 bicyclists. More bicyclists than pedestrians were counted throughout the evening, with 5 people riding skateboards. This location is in close proximity to the Mather Sports Complex, which has a skate park.

Zinfandel Drive at Highway 50 Interchange

This location is challenging for pedestrian activity because of the existing one- and two-lane free-flow entrance ramps. Pedestrian activity was steady throughout the morning study period, with a peak at 7:00 AM–8:00 AM yielding 12 pedestrians and 13 bicyclists. There was one jaywalker and some cyclists who appeared to be commuters. In the evening, pedestrian activity was low with two peak periods from 3:45 PM to 4:45 PM, with 11 pedestrians and 2 bicyclists, and from 5:00 PM to 6:00 PM, with 8 pedestrians and 5 bicyclists. Some small groups were observed coming from the light rail station. Many from these groups had bags or backpacks. Nearby destinations for students include Heald Business College, IIT Technical Institute, or the University of Phoenix.



PEDESTRIAN COLLISION ANALYSIS

The rate of pedestrian collisions in Rancho Cordova has varied since city incorporation in 2003. Collision totals ranged between 20 and 29 from 2004 to 2008. Pedestrian collisions have most frequently occurred around transit stations and commercial areas, with the highest number of pedestrian-involved collisions along Folsom Boulevard, Coloma Road, and Mather Field Road. Pedestrian-involved collisions occurred most frequently at intersections, with most collisions taking place during daylight hours, when pedestrian activity is greatest around transit stations and other pedestrian hot spots.

All Pedestrian Collisions By Year

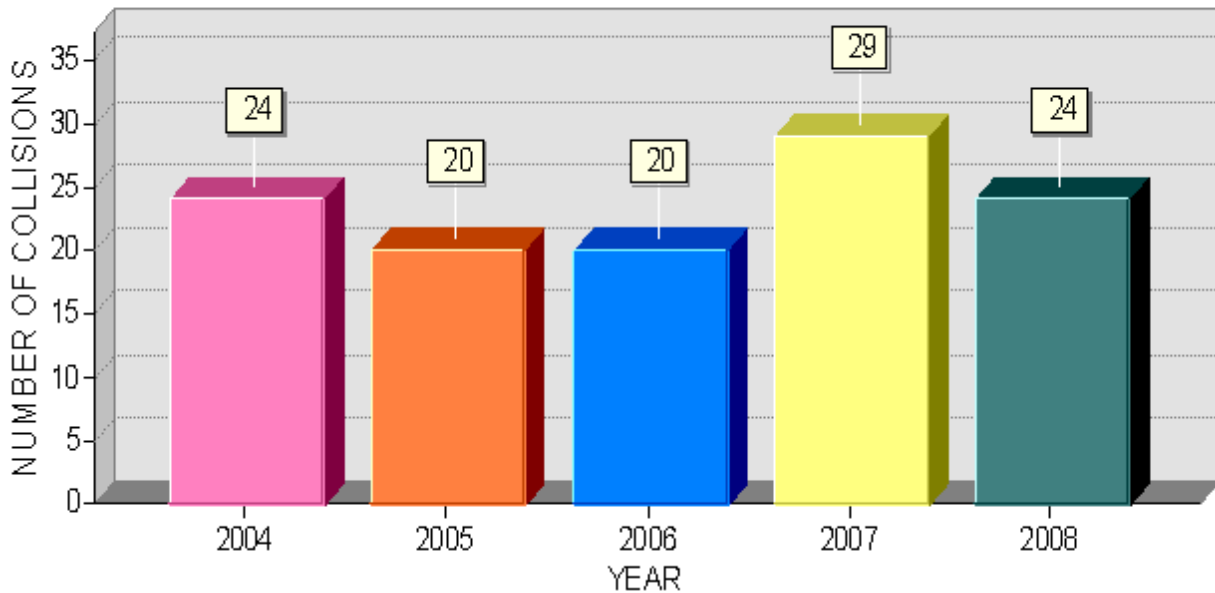

BARRIERS TO PEDESTRIAN ACTIVITY

The City intends to increase the percentage of people who choose to walk to work, to school, or to other commercial or recreational opportunities. Replacing driving trips with walking trips reduces congestion and automotive emissions. Pedestrians who regularly walk for transportation and recreation gain cardiovascular health and reduce their risk of heart disease and obesity. Both benefits result in overall greater quality of life for the community.

Numerous barriers to pedestrian activity exist in Rancho Cordova, in the form of major transportation corridors and geographic impediments like the American River and the Folsom South Canal. The City is bounded to the north by the American River and is bisected by Highway 50. The Folsom South Canal generally runs along the eastern boundary of the existing neighborhoods in the City and currently is not a major impediment to travel.



CHAPTER 4 • NEEDS ASSESSMENT

However, as new development occurs east of Sunrise Boulevard, both the canal and Sunrise Boulevard will need to be bridged so that pedestrian trips can be made that will access City amenities on both sides.

HIGHWAY 50

Three locations along approximately 8 miles of Highway 50 within the City provide good connections to neighborhoods on both sides of the highway. These locations include Routier Road between Bradshaw Road and Mather Field Road, Folsom Boulevard just west of Sunrise Boulevard, and the Citrus Road bike trail undercrossings east of Sunrise Boulevard.

Additional pedestrian crossing opportunities are provided at the five interchanges along Highway 50. However, free-flow on/offramps can be very challenging for pedestrian travel. Caltrans has initiated a study and has made recommendations for ways that freeway interchanges can be designed to be more bicycle and pedestrian friendly. As the City considers upgrades to the existing interchanges along the highway and builds a new interchange east of Sunrise Boulevard, these design features should be implemented. In the short term, the City will look for retrofit design concepts that can improve pedestrian access at interchanges.

LOCALIZED BARRIERS TO TRAVEL

Localized barriers to pedestrian travel include missing sections of sidewalk, sidewalk in disrepair, and long block length along busy roadways with pedestrian generators between intersections. A missing or broken section of sidewalk can be a significant impediment, particularly for senior citizens or people with disabilities, and can make the difference between choosing a walking trip or a driving trip. Major pedestrian generators, such as transit stations, commercial locations, or apartment complexes, along streets like Folsom Boulevard could also be greatly enhanced with midblock signalized pedestrian crossings. These facilities are critical to support walking trips.

FOLSOM BOULEVARD SIDEWALK REPLACEMENT

There is an ongoing need to replace, or cause to be replaced, all sidewalks on the north side of Folsom Boulevard. In many locations this walk is divided by driveway cuts and in some locations older walks may create barriers for disadvantaged populations. Walk replacement is occurring as part of the Folsom Boulevard improvement projects and as part of new development projects. As the City continues to evaluate pedestrian program priorities and ADA access issues a plan will be developed that will complete the replacement effort.

LAND USE CONCEPTS THAT ELIMINATE BARRIERS

According to the Sacramento Area Council of Government's Metropolitan Transportation Plan 2035, new development areas should consider higher residential and employment densities in the vicinity of transit corridors so that expanded transit service can be successful. These higher-density areas would be developed near community activity centers, close to regional job centers, and along key transit corridors. Balancing



commercial sites, residential development, and employment centers in close proximity to one another will enable a greater number of Rancho Cordova residents to walk for transportation.

PUBLIC TRANSPORTATION

Walking is often a key component along a travel trip chain that includes walking to a station from home or walking to a work or recreational destination from the train or bus. Eliminating access barriers to transit stations can increase overall walking trips, as can additional transit service such as streetcars or transit shuttles that connect underserved areas or cross barriers to pedestrian travel such as Highway 50.





Chapter 5:
IMPLEMENTATION





5

CHAPTER 5

Implementation

Implementation of pedestrian improvements outlined in this chapter will require a significant investment from both the City and the community. Many of the improvement projects recommended by this Pedestrian Master Plan, such as sidewalk infill and repair, are a collection of many relatively small and inexpensive projects that are integrated into the City’s annual work plan. Large-scale projects, such as pedestrian bridges and trail connections, are identified in the Bikeway Master Plan and will require the collaborative work of City staff, the private development community, and local advocacy groups. This investment in Rancho Cordova’s pedestrian infrastructure will help the City become the walkable community that is envisioned by the City’s General Plan.

Capital costs identified in this Plan total approximately \$13 million as shown in Table 5.1. Generally, these capital investments will be provided through annual or ongoing improvement programs. The Bikeway Master Plan includes major pedestrian infrastructure projects such as The Promenade, which builds a trail or route system that will be used by pedestrians. Figure 5.1 shows planned pedestrian improvements.

Table 5.1: Pedestrian Master Plan Cost Summary

Master Plan Cost Categories	Cost (2009 Dollars)
Sidewalk Infill Opportunities	\$8,200,000
Intersection Improvements	\$2,840,000
Sidewalk Repair	\$1,420,000
Midblock Signalized Crossing	\$300,000
Walkway Upgrades	\$180,000
Lighting Improvements	\$60,000
Total Estimate	\$13,000,000





PEDESTRIAN IMPROVEMENTS

- SIGNALIZED INTERSECTIONS
- EXISTING MIDBLOCK CROSSING
- PROPOSED MID BLOCK CROSSING
- WALKWAY UPGRADES
- REQUESTED LIGHTING IMPROVEMENTS
- SIDEWALK REPAIR LOCATION
- SIDEWALK INFILL OPPORTUNITY
- PROPOSED CLASS I BIKE PATH / WALKWAY
- EXISTING CLASS I BIKE PATH/WALKWAY
- EXISTING CITY BIKE ROUTE
- PROPOSED CITY BIKE ROUTE
- EXISTING OVERCROSSING
- EXISTING UNDERCROSSING
- INTERCHANGE WITH PEDESTRIAN ACCESS

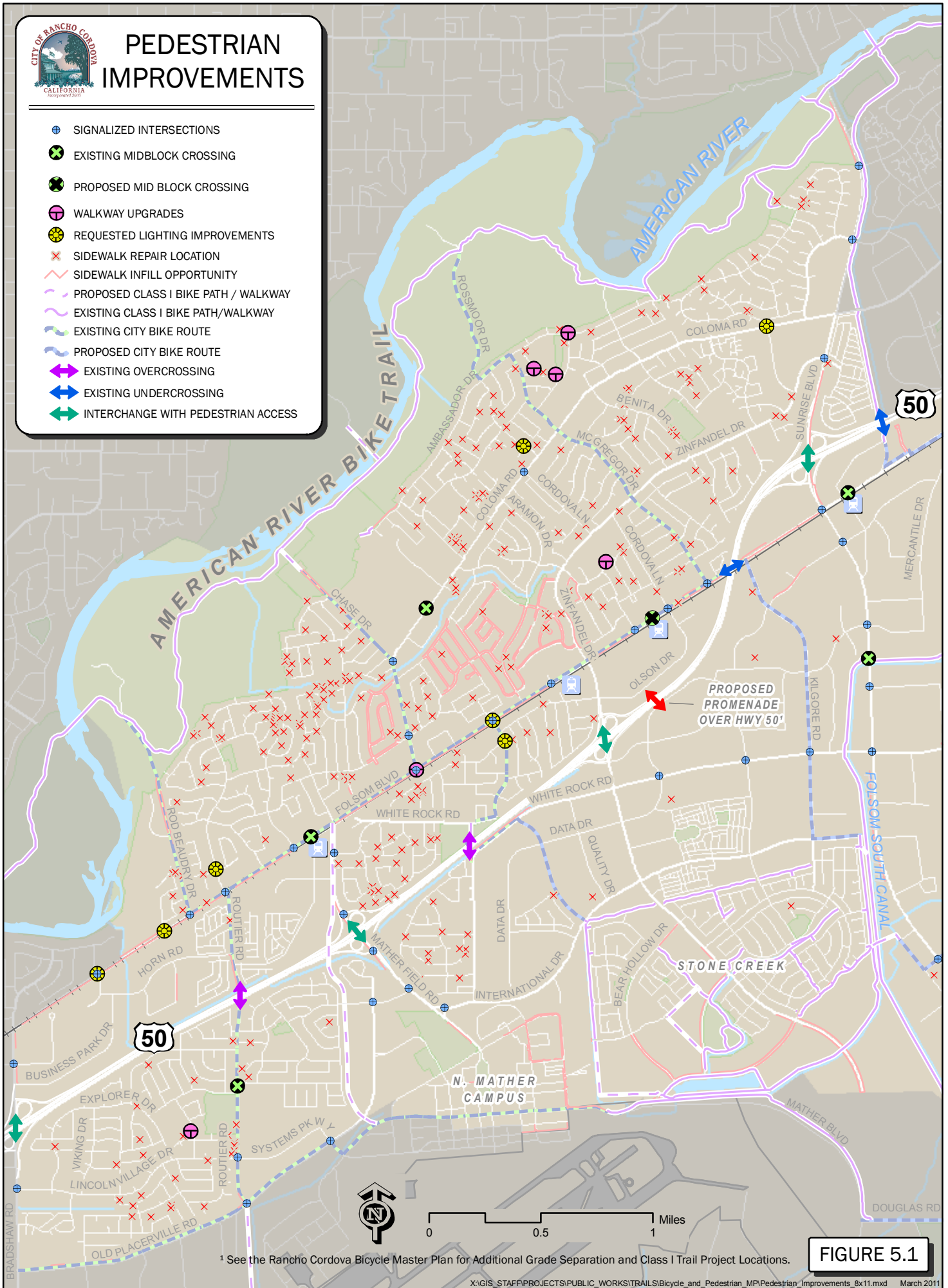

¹ See the Rancho Cordova Bicycle Master Plan for Additional Grade Separation and Class I Trail Project Locations.

FIGURE 5.1

SIDEWALK INFILL OPPORTUNITIES

As part of the City’s Complete Streets initiative, the Pedestrian Master Plan identifies street locations where adjacent sidewalk is not provided. The City works to fill these sidewalk gaps through an annual program and through other roadway improvement projects.

The City has evaluated 49 sidewalk infill locations for cost as part of the Pedestrian Master Plan. The estimated cost to improve these locations is \$8.2 million. These funds will build approximately 78,000 lineal feet of sidewalk with about 4,000 feet of curb and gutter. Approximately half of the \$8.2 million is needed for the purchase of right-of-way.

There are many other locations where sidewalk is needed. Current projects such as the International Drive Extension and the Folsom Boulevard Streetscape Improvements projects will build sidewalks along Sunrise Boulevard and Folsom Boulevard. Other current gap fill projects include Horn Road, International Drive at Capital Center Drive, and the Sunrise Boulevard widening project north of White Rock Road. Land developers and other agencies will build sidewalks in the Stone Creek neighborhood and the North Mather Campus as part of ongoing development efforts. Sections of Sunrise Boulevard north of Folsom Boulevard will need to be evaluated for feasibility prior to further project development work.

SIGNALIZED INTERSECTION IMPROVEMENTS

Pedestrian signals and crosswalks should be provided on all legs of every signalized intersection. In addition, the City will consider larger corner pedestrian plazas, pork chop islands, and median pedestrian refuges so that intersections are more attractive for pedestrian use.

In order to prepare a planning-level cost estimate for these improvements, approximately 50 signalized intersection locations were evaluated for crosswalk, pedestrian push button, and pedestrian plaza opportunities. As shown in Table 5.2, an approximately \$2.8 million funding need was identified at these signalized intersections to add approximately 40 crosswalks, 80 pedestrian push buttons, and 60 pedestrian plazas. This estimate is intended to provide an order-of-magnitude need for the improvements. Detailed evaluation and feasibility will be performed as part of annual improvement projects and other roadway improvement efforts.



Table 5.2: Planning Estimate for Intersection Improvements

Type of Improvement	Approximate Number of Locations	Estimated Cost Per Location	Total Estimated Cost
Crosswalk Striping	40	\$20,000	\$800,000
Pedestrian Push Buttons	80	\$15,000	\$1,200,000
Pedestrian Plazas	60	\$14,000	\$840,000
Total			\$2,840,000

SIDEWALK REPAIR

During the 2003 incorporation process, the City inherited a list of over 300 locations where residents had identified potential sidewalk repair needs. Many locations have been evaluated and do not need immediate action, but will require continued monitoring for tree root heaving or other degrading environmental effects. The City replaces damaged sidewalk in about 20 locations each year as part of an annual repair program and repairs approximately 10 additional locations by grinding irregularities in the sidewalk surface.

In order to gauge the magnitude of the citywide sidewalk repair need, the Pedestrian Master Plan estimates the cost of replacing sidewalk in all 290 locations at approximately \$1,420,000. This work would build about 16,000 square feet of sidewalk and replace about 5,600 lineal feet of curb and gutter.

MIDBLOCK CROSSINGS

The Institute of Transportation Engineers has identified a set of criteria for adding a signalized pedestrian crossing of major roadways. These criteria include minimized spacing with signalized intersections, a threshold volume and speed of traffic, crossing of multiple lanes without refuge, and pedestrian generators that will be served on either side of the street. The City of Rancho Cordova has five midblock signalized pedestrian crossing locations.

1. Folsom Boulevard at the Mather Field/Mills Light Rail Station
2. Coloma Road at Cordova High/Mills Middle School site
3. Folsom Boulevard at the Sunrise Light Rail Station
4. Sunrise Boulevard at the Folsom South Canal
5. Routier Road between Ellenwood Avenue and Vanguard Drive



CHAPTER 5 • IMPLEMENTATION

A sixth location is planned along Folsom Boulevard at the Cordova Town Center Light Rail Station, and a seventh location is identified in the Bikeway Master Plan that will be built on Zinfandel Drive along the North Stone Creek Trail. The anticipated cost for the Cordova Town Center signalized pedestrian crossing is \$300,000. Other locations will be considered in the future as needed.

PEDESTRIAN PATHWAY UPGRADES

There are six pathways within the City, four that provide walking shortcuts for residents and for schoolchildren who are walking to school and one connecting residents to the American River Parkway. A sixth location provides a connection between Mills Tower Drive and Folsom Boulevard at Coloma Road. These connections take the form of 12- to 16-foot-wide easements or City-owned rights-of-way between residential properties. Three additional pedestrian paths have recently been closed due to disuse and safety concerns.

The Mills Tower pathway will be improved through a \$70,000 Community Development Block Grant that will upgrade the desirability of the connection, realigning the path, clearing vegetation, building new fences, and creating-graffiti resistant surfaces. The remaining five locations are in need of vegetation clearing, walkway repair, improved lighting, and ADA transitions at the ends of the walkways. The anticipated cost for each of these locations is \$22,000.

STREET LIGHTING

The City inherited seven citizen requests for street lighting at incorporation. An eighth location was requested in 2008 near an apartment complex along West La Loma Drive. City staff is working to develop criteria for added street lighting and engaging the community to clarify local residents' desires. A planning cost of \$5,000 to \$10,000 per location is anticipated. See Table 5.3 for the cost of eight roadways with planned street lighting improvements.



Table 5.3: Planning Estimate for Street Lighting

Locations	Total Estimated Cost
Coloma Road at Vehicle Drive	\$5,000
Mills Park Drive at Mills Tower Drive	\$5,000
West La Loma Drive at Terra Loma Drive	\$10,000
Averell Court at Rossmoor Drive	\$10,000
Folsom Boulevard at Tiffany West Way	\$5,000
Folsom Boulevard at Horn Road	\$10,000
Folsom Boulevard at Mills Park Drive	\$5,000
Douglas Road at Grant Line Road	\$10,000
Total	\$60,000

UNMARKED ACCESS DISCUSSION FOR AMERICAN RIVER PARKWAY

There are six short roadways within city limits that have been stubbed into the American River Parkway. These locations are used for pedestrian access but are not official marked access points. While these locations increase access to the parkway, local residents have concerns about how they are used.

Concerns focus on recreational parking, nuisance park users, and loss of privacy. At the Levee Road and Dedo Way locations, the City has installed bollards across the short roadways to address recreational parking concerns. Local residents have expressed concerns with four other locations with similar configurations: River Vista Way, Lewitt Drive, Cranor Drive, and Givet Way. The City intends to work with enforcement agencies to develop a plan to make these access points viable for parkway users while addressing the nuisance concerns of local residents.

FUNDING OPPORTUNITIES

Funding opportunities include the following sources: state bond funds, hazard mitigation funds, Transportation Development Act/SAFETEA funds, congestion management and air quality funds, Community Development Block Grants, and the use of developer fee credits. A brief description of each proposed source appears below.



FEDERAL AND STATE FUNDING SOURCES

Transportation Development Act/Surface Transportation Reauthorization

The Transportation Development Act (TDA) is administered by Caltrans and provides funding for transportation through regional transportation planning agencies. Pedestrian and bicycle facility improvements may be eligible for TDA funding. A one-quarter-cent sales tax collected by the state and redistributed to each city generates TDA funds. The great majority of the funds goes to transit operations. However, if transit needs are met in a given fiscal year, surplus funds may be available for other transportation-related uses. A funding source with similar characteristics is the Safe, Accountable, Flexible and Efficient Transportation Equity Act: Legacy for Users (SAFETEA-LU Act), which is the major federal source of transportation grant funding.

American Reinvestment and Recovery Act Funds

The American Reinvestment and Recovery Act (ARRA) provides a diverse range of grants and other funding programs for local governments, including \$77 million in Transportation Enhancements (TE) funds for California. In accordance with state legislation to implement the recovery act, ABX3 20, bicycle and pedestrian projects are the second priority for TE-funding projects. The majority of TE funds will be programmed by metropolitan planning organizations and regional transportation planning.

Congestion Management and Air Quality

Similar to TDA/SAFETEA, congestion management and air quality funding focuses on mobility projects with the potential to reduce vehicle trips and emissions.

Land and Water Conservation Fund

Last year this National Park Service program, administered at the state level by the Department of Parks and Recreation, had \$1.3 million available statewide for acquisition or development of land and facilities that provide or support public outdoor recreation.

Recreational Trails Program

The Recreational Trails Program is a SAFETEA-LU program administered by the Federal Highway Administration. Nationally, \$80 and \$85 million was authorized for 2008 and 2009, respectively, to develop and maintain trails and trail-related facilities.

Community Development Block Grants

The U.S. Department of Housing and Urban Development provides funds for community-based projects.

Safe Routes to School Funding (State Program)

The State of California funds \$20 million annually in traffic calming and non-motorized transportation improvements near schools. The City of Rancho Cordova has recently implemented Safe Routes to School projects after successful bids for funding.



Safe Routes to School Funding (Federal Program)

In August 2005, the United States Congress established the national Safe Routes to School program in Section 1404 of the Safe, Accountable, Flexible, Efficient Transportation Equity Act – A Legacy for Users (SAFETEA-LU). This landmark legislation designated \$612 million in federal transportation funds for Safe Routes to School programs nationwide.

Federal TIGER I & II Program

In 2010, the U.S. Department of Transportation gave out a total of \$2.1 billion for innovative transportation projects that address economic, environmental, and travel issues at once. The TIGER program, as it's known (Transportation Investments Generating Economic Recovery), is a competitive and merit-based process to pick projects and should be a model for the next transportation authorization.

Sacramento Area Council of Governments, Bike and Pedestrian Program

In 2002, SACOG approved a program that provides \$350 million of funding for bicycle and pedestrian projects through 2025. The program is supported by federal means, and projects are selected biannually through a competitive application process.

LOCAL FUNDING AND FINANCING SOURCES

Developer Impact Fees and Fee Credits

In some instances, it may be mutually beneficial for the City and a particular private developer to agree on a combination of development impact fees, fee credits, land dedication, and/or capital improvements in order to most effectively move a project forward. Allowing fee credits in lieu of fees will be at the discretion of the City. Traffic generation impact fees are typically tied to trip generation rates and traffic impacts from proposed development and may be used to install Class II facilities.

Private Grant Funding

There are thousands of private foundations with grant programs providing park and recreation funding. The National Recreation and Park Association (www.nrpa.org) and the Foundation Center (www.foundationcenter.org) maintain websites with information on grant opportunities.

PARTNERSHIP OPPORTUNITIES

As public funding for nonessential programs and services becomes increasingly scarce, jurisdictions nationwide find themselves leveraging their resources in increasingly creative ways. One of the best ways for municipal governments to leverage existing resources is by partnering with organizations that share common goals, such as promoting bicycling, improving public health, promoting sports, and conserving natural resources. Partnerships can provide donations of land, materials, money, or volunteer time.



CHAPTER 5 • IMPLEMENTATION

It is recommended that the City begin to formalize the most successful of its existing partnerships through the adoption of Memorandums of Understanding (MOU). Adoption of an MOU helps to memorialize the informal partnership agreement and clearly delineate responsibility for maintenance and operations of shared facilities.

Jurisdictions throughout California and the nation have long benefited from partnerships with private, nonprofit organizations that are motivated to assist with maintenance, renovations, and new improvements in their communities. Partnerships with nonprofit organizations should be formalized with an MOU, even if no funds are changing hands. Formalizing the partnership through a written agreement helps to manage expectations and ensure accountability for both parties.

A list of potential partners includes the following organizations:

- Local schools – Folsom Cordova Unified School District, Elk Grove Unified School District, and local private schools
- Rancho Cordova Police Department
- Caltrans Local Assistance
- 50 Corridor TMA
- Walk Sacramento
- Rancho Alliance of Neighborhoods
- Cordova Recreation and Park District
- Sacramento Area Council of Governments (SACOG)
- Sacramento County Regional Parks





Appendix A:
PEDESTRIAN STANDARDS





APPENDIX A

Pedestrian Standards



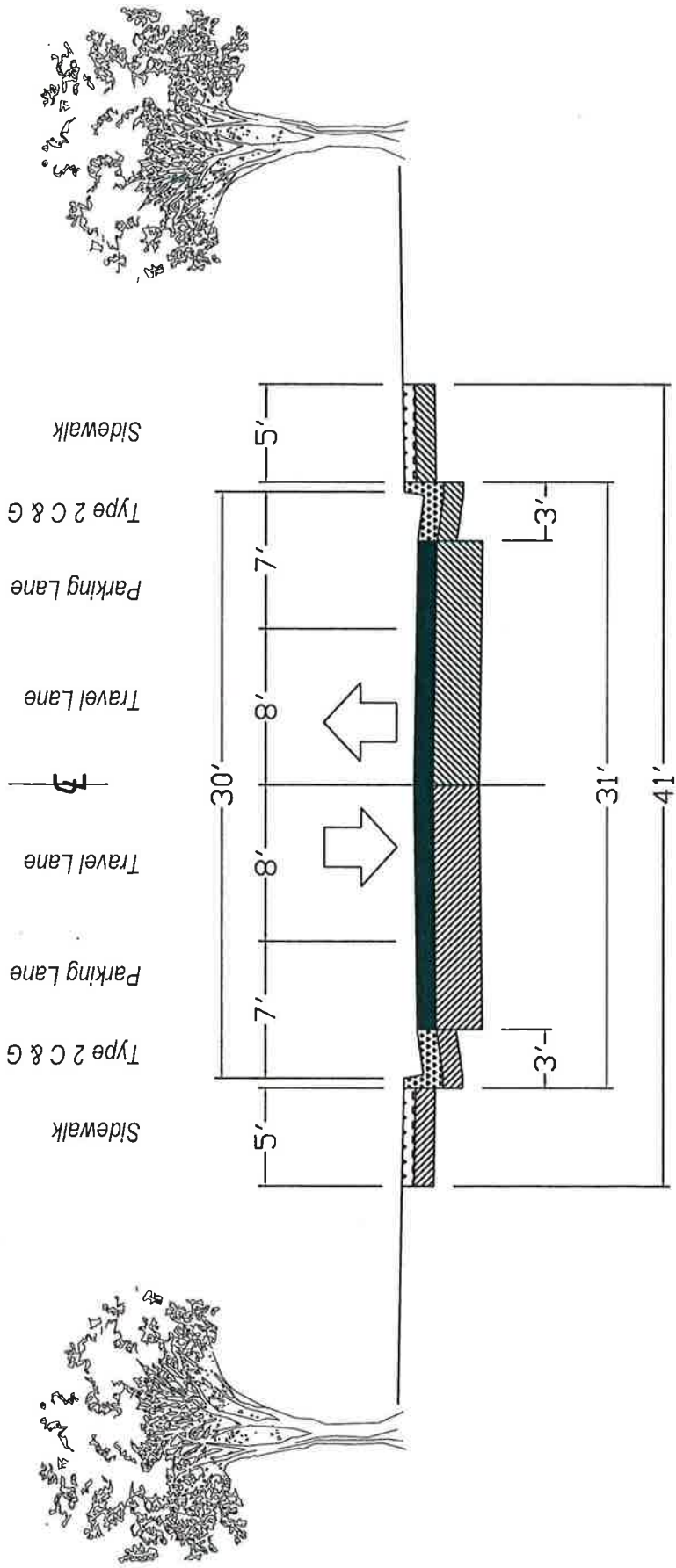

Cyrus Alchor
 DIRECTOR OF PUBLIC WORKS



CITY OF RANCHO CORDOVA
 PUBLIC WORKS

Minor Residential Streets

SCALE: NONE
 DATE: JUNE 2006
 DRAWN BY: MATTHEW RUBLE

CS - 01

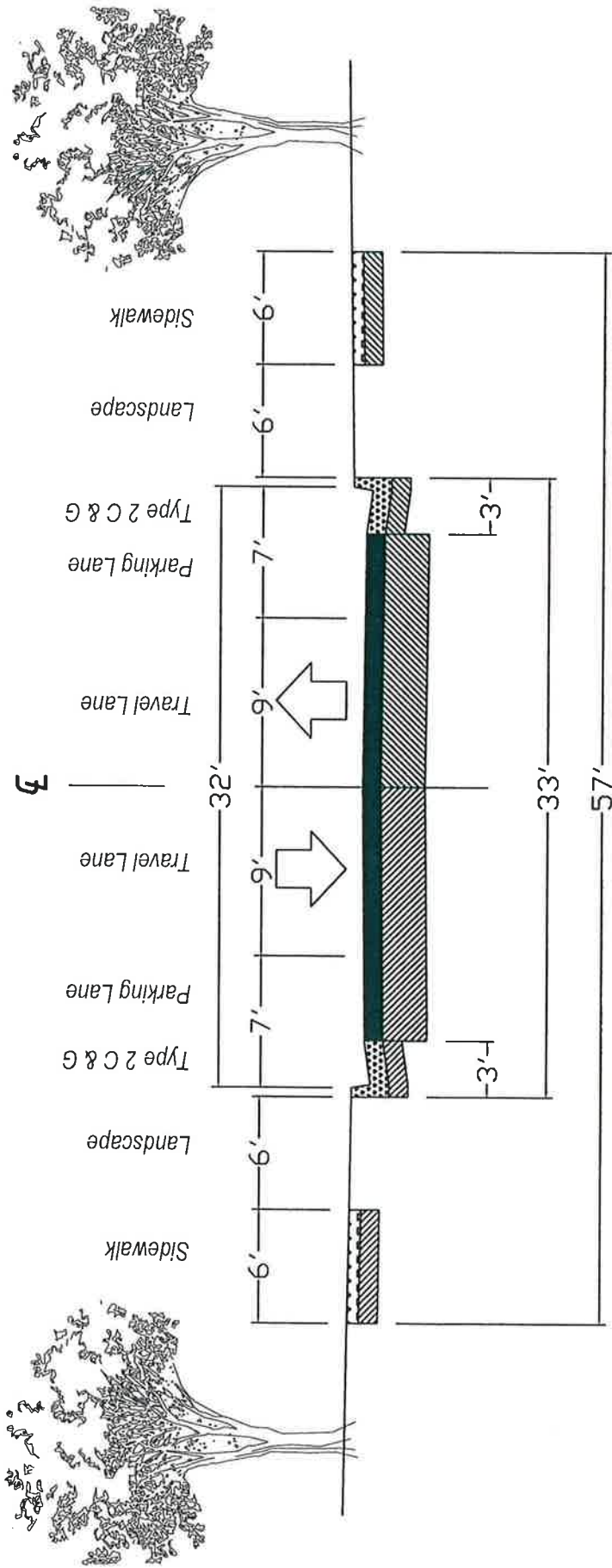

Cyrus Alvar

DIRECTOR OF PUBLIC WORKS



CITY OF RANCHO CORDOVA
PUBLIC WORKS

Standard Residential Streets

SCALE: NONE
DATE: JUNE 2006
DRAWN BY: MATTHEW RUBLE

CS - 02

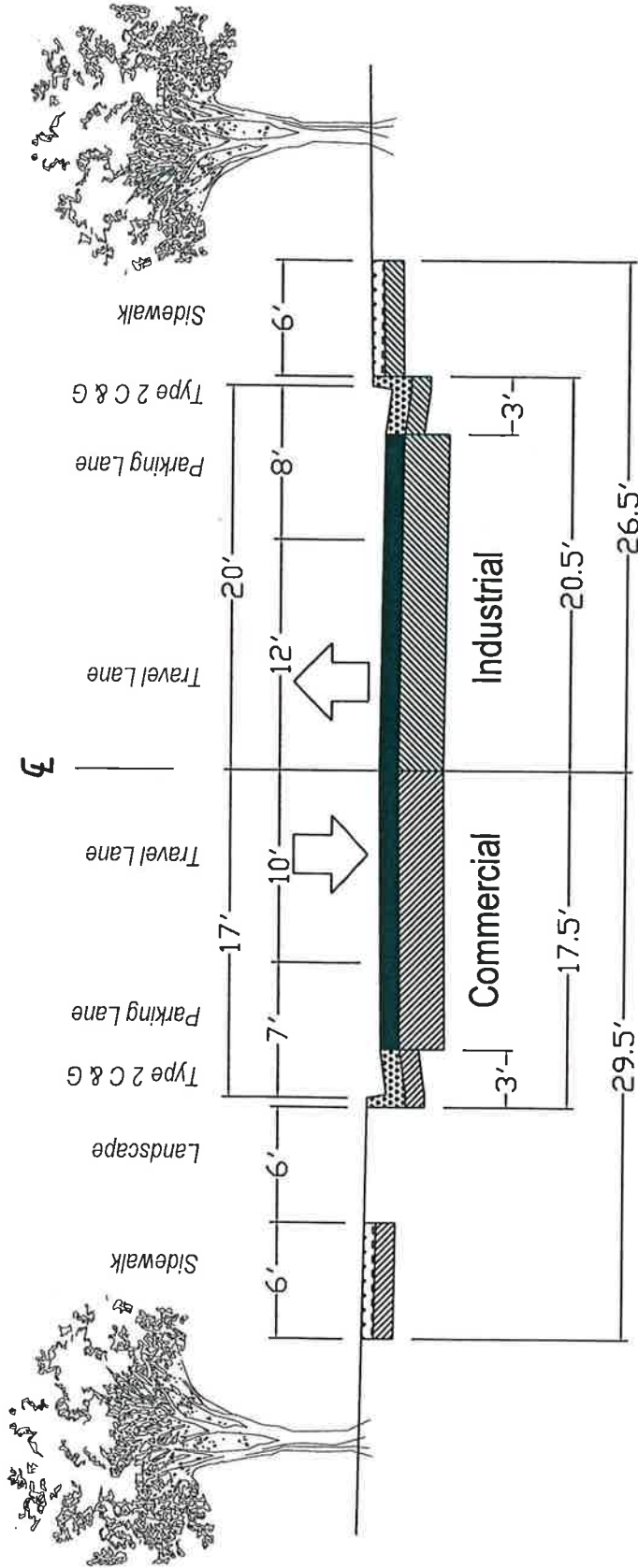

Cyrus Akh

DIRECTOR OF PUBLIC WORKS



CITY OF RANCHO CORDOVA
PUBLIC WORKS

Non-Residential Local Streets

SCALE: NONE
DATE: JUNE 2006
DRAWN BY: MATTHEW RUBLE

CS - 03

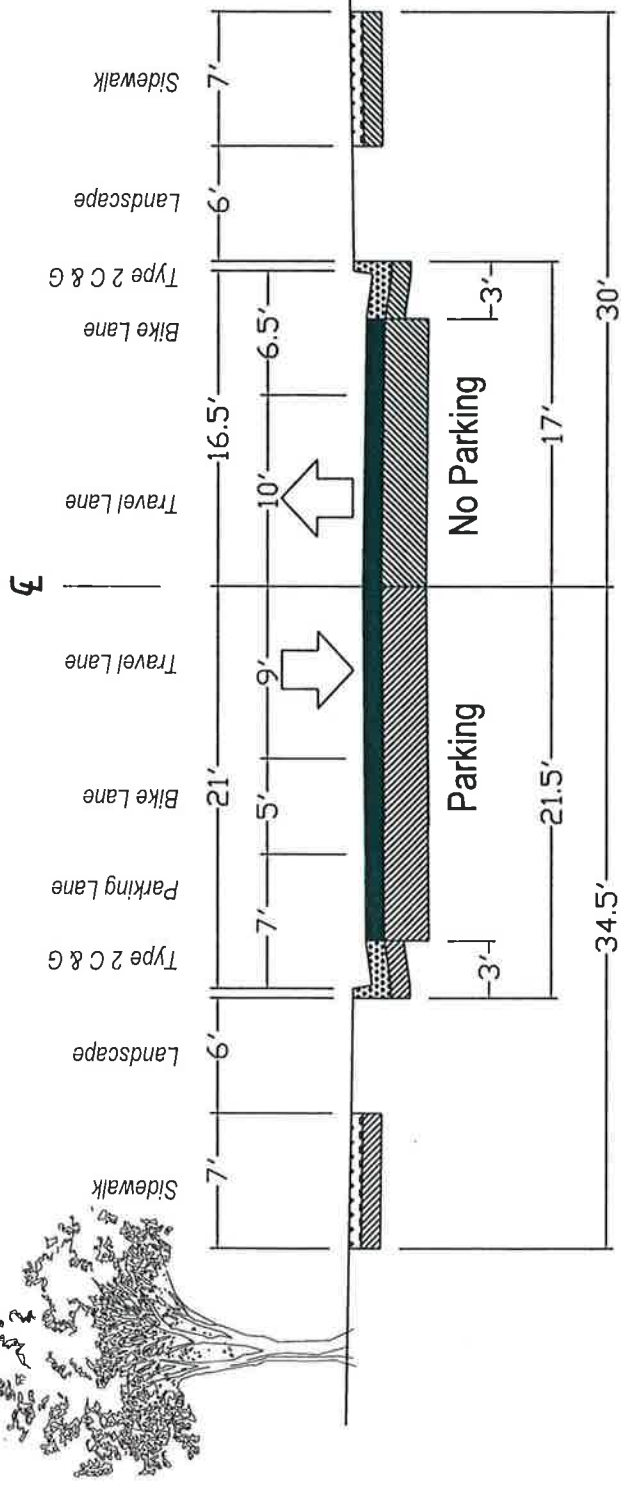
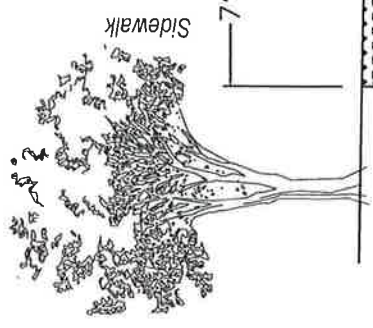
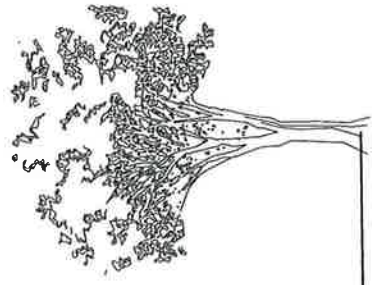

Elynn Allen
 DIRECTOR OF PUBLIC WORKS



CITY OF RANCHO CORDOVA
 PUBLIC WORKS

Residential Collector Street

SCALE: NONE
 DATE: JUNE 2006
 DRAWN BY: MATTHEW RUBLE

CS - 04

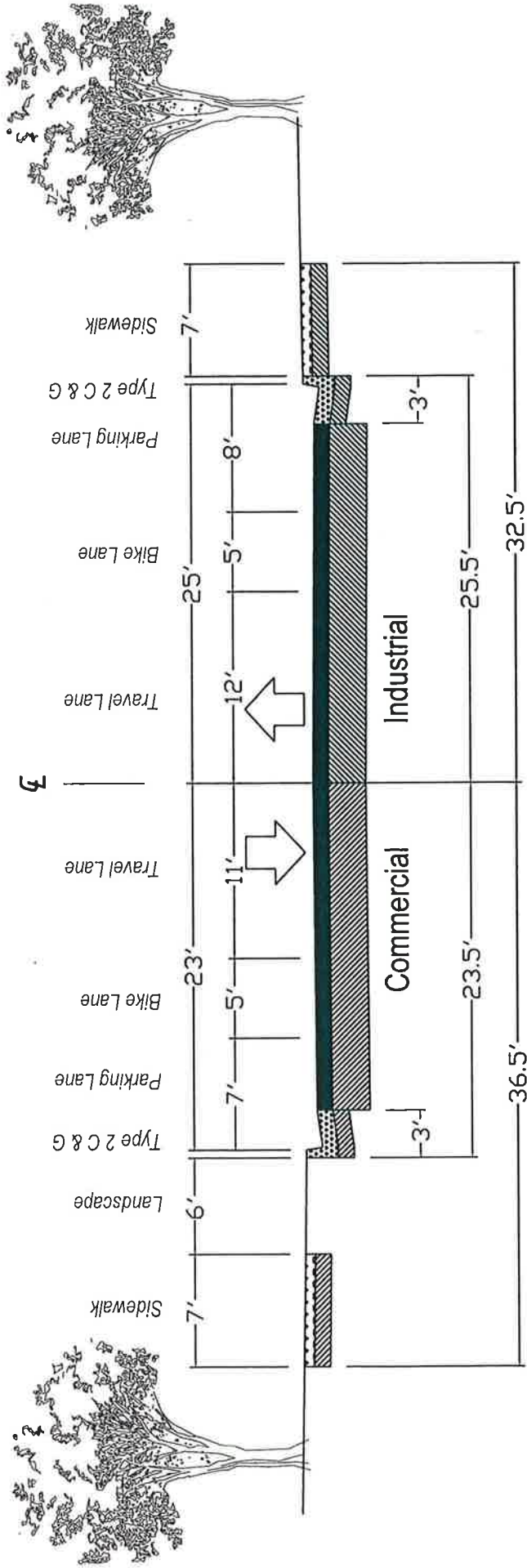

Note: Provision of a 14 ft wide raised median is optional

Lynn Allen
 DIRECTOR OF PUBLIC WORKS



CITY OF RANCHO CORDOVA
 PUBLIC WORKS

Non-Residential Collector Street

SCALE: NONE
 DATE: JUNE 2006
 DRAWN BY: MATTHEW RUBLE
 CS - 05

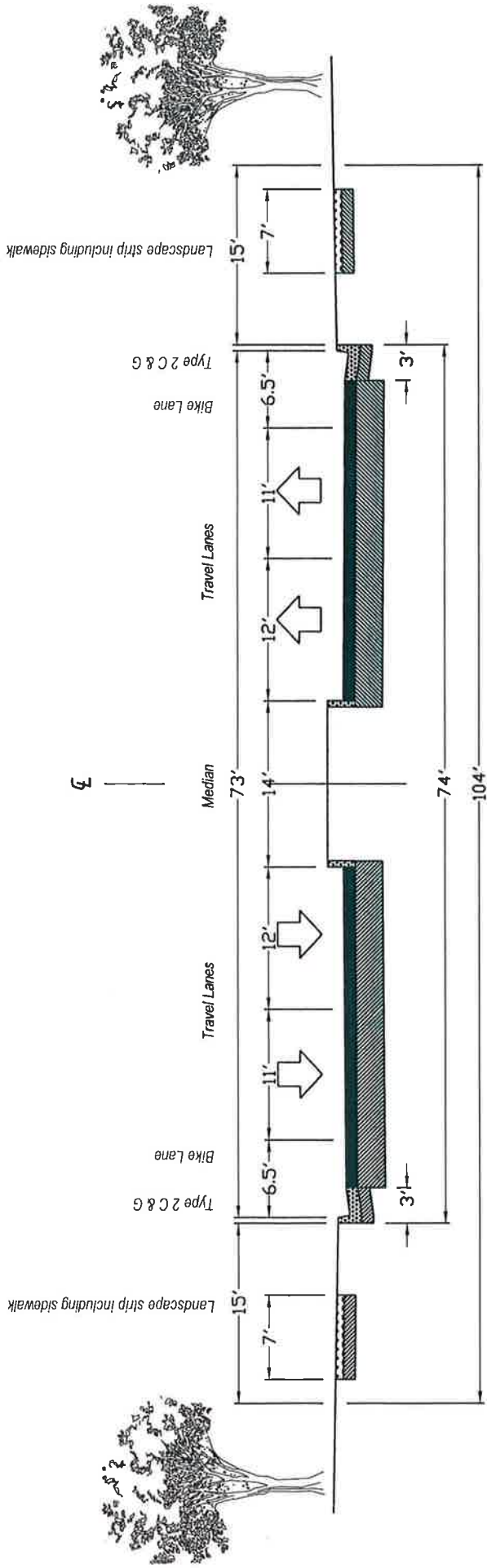

Note: Sidewalk location can vary within 15 ft landscape strip

lyn all

DIRECTOR OF PUBLIC WORKS



CITY OF RANCHO CORDOVA
PUBLIC WORKS

Minor Arterial

SCALE: NONE
DATE: JUNE 2006
DRAWN BY: MATTHEW RUBLE

CS - 06

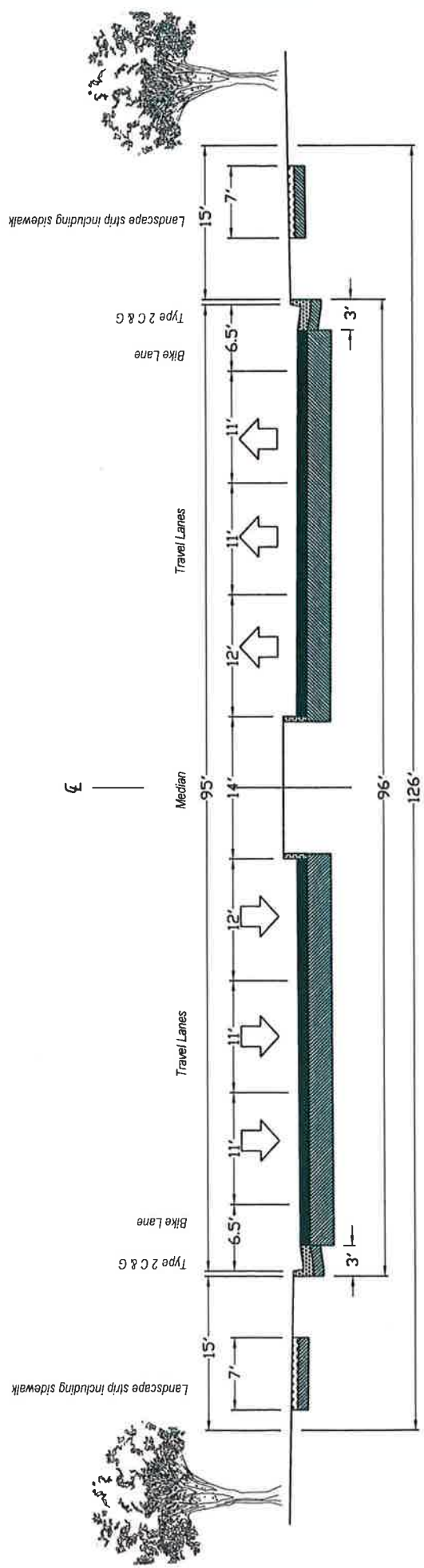

Note: Sidewalk location can vary within 15 ft landscape strip

Byron Alala

DIRECTOR OF PUBLIC WORKS

CITY OF RANCHO CORDOVA
PUBLIC WORKS



CITY OF RANCHO CORDOVA
CALIFORNIA
Incorporated 2001

Major Arterial

SCALE: NONE
DATE: JUNE 2006
DRAWN BY: MATTHEW RUBLE

CS - 07

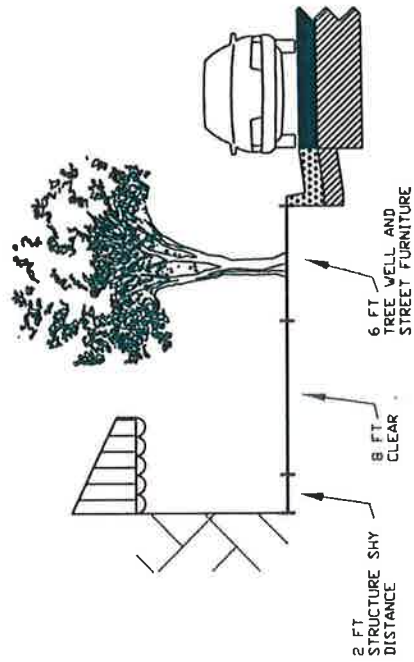
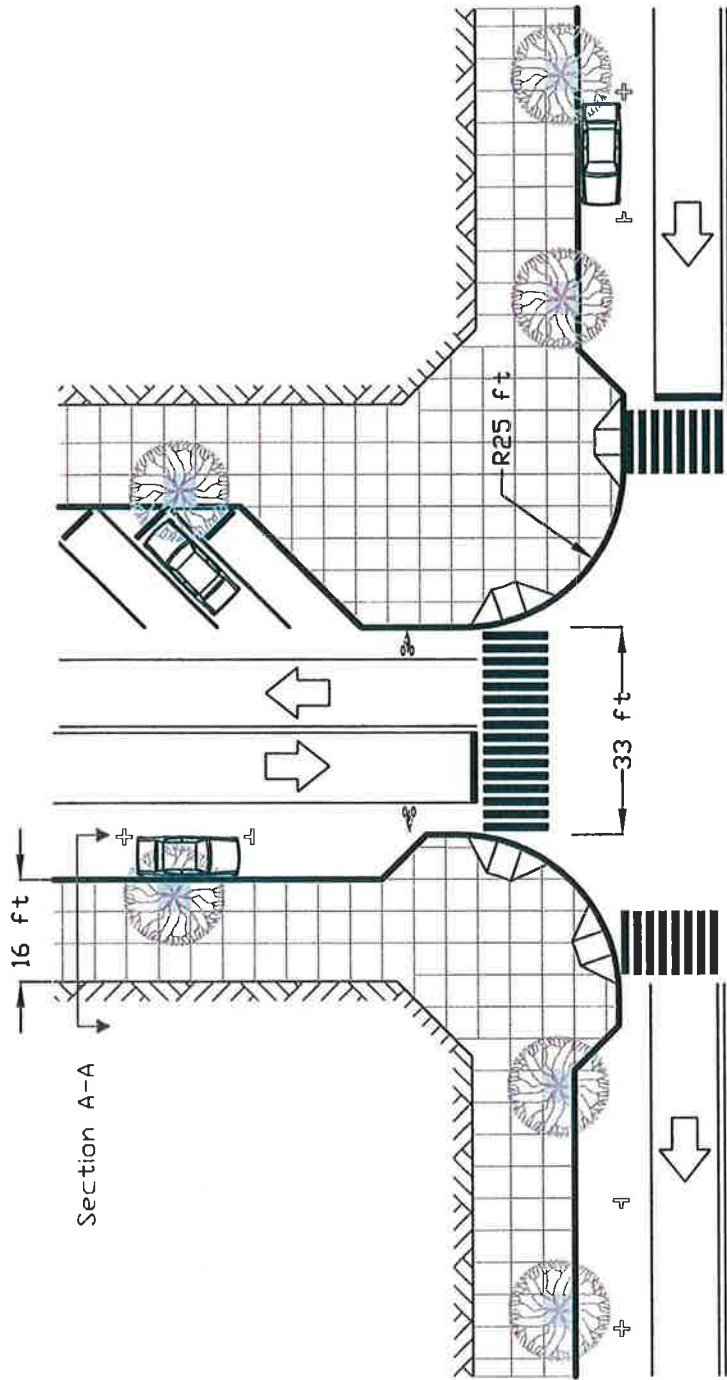

Lynn Allen

DIRECTOR OF PUBLIC WORKS



CITY OF RANCHO CORDOVA
PUBLIC WORKS

Main Street

SCALE: 1" = 30'
DATE: JUNE 2006
DRAWN BY: MATTHEW RUBLE

MD - 02

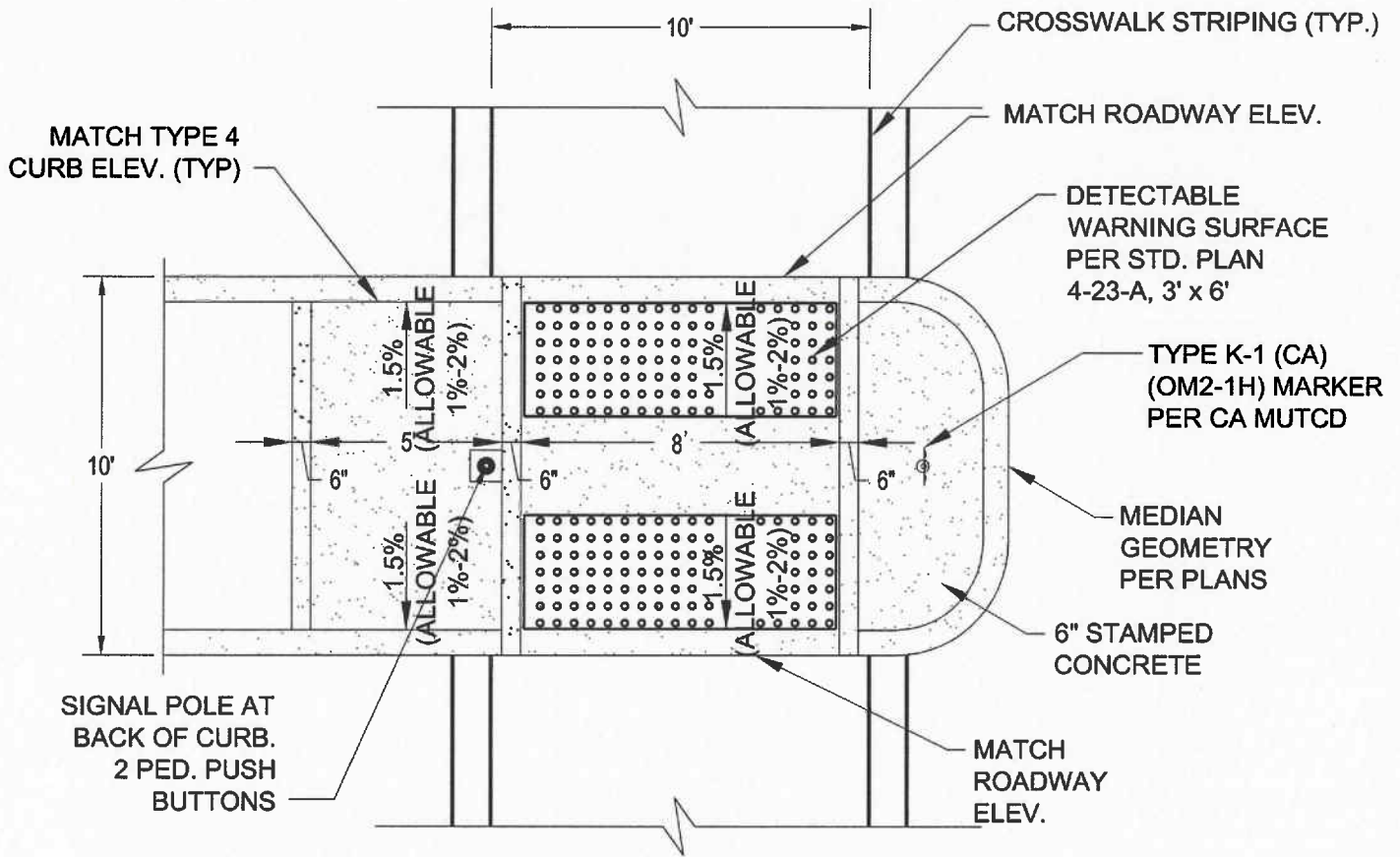

PLAN VIEW

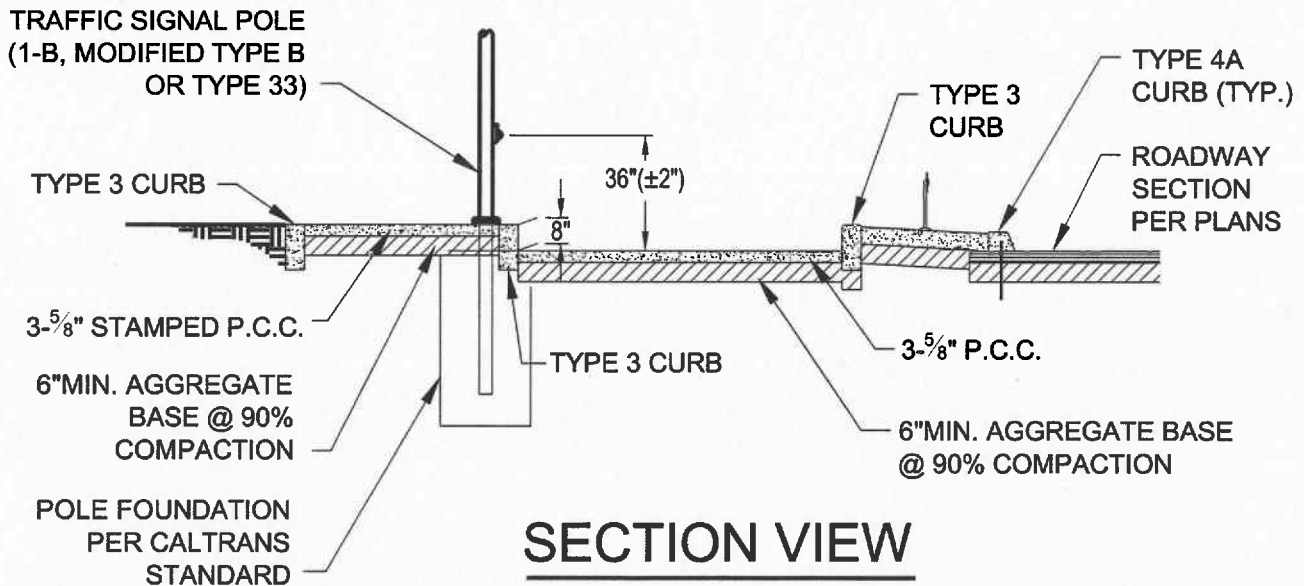

SECTION VIEW

NOTES:

- FOR SIGNAGE CLEARANCES SEE MUTCD FIGURE 9B-1

Cyrus Akab

DIRECTOR OF PUBLIC WORKS

CITY OF RANCHO
CORDOVA PUBLIC
WORKS



MEDIAN PEDESTRIAN REFUGE

SCALE: 1" = 5"
DATE: JUNE 2009
DRAWN BY: TE

BP - 03

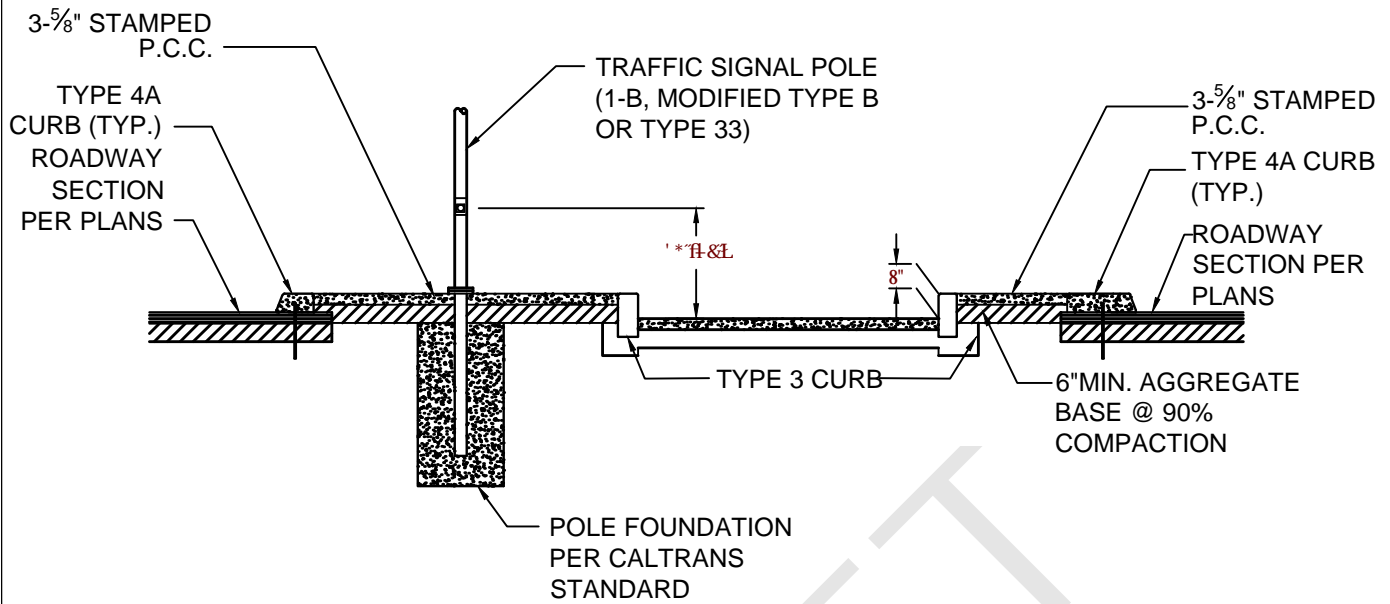

PORKCHOP - SECTION A

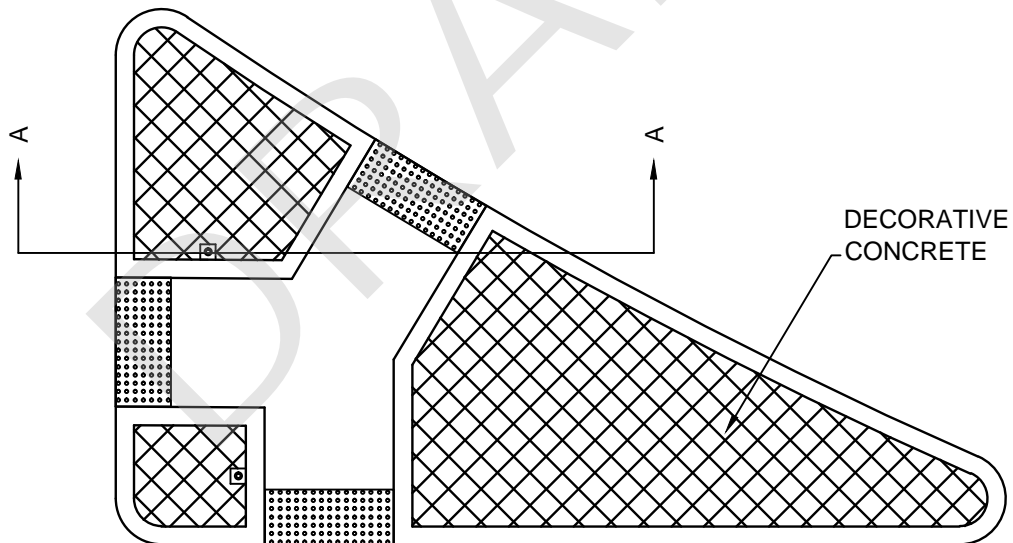

PORKCHOP - PLAN VIEW

DIRECTOR OF PUBLIC WORKS

CITY OF RANCHO
CORDOVA PUBLIC
WORKS



RAISED ISLAND
PEDESTRIAN REFUGE

SCALE: NTS
DATE: FEBRUARY 2010
DRAWN BY: TE

XX - XX

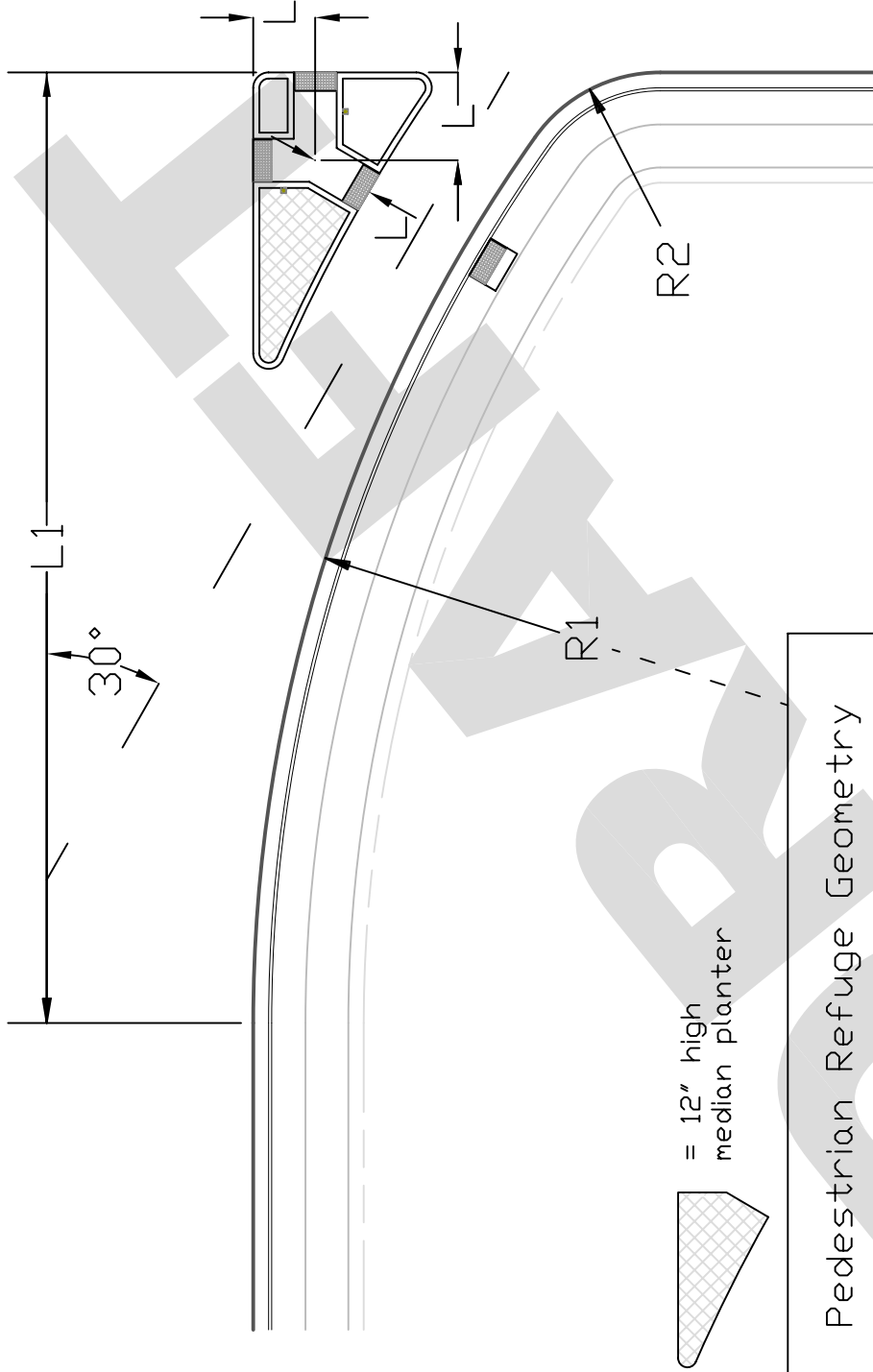

= 12" high median planter

Pedestrian Refuge Geometry				
	R1	R2	R1 Point of Curvature Offset (L1)	L
No RT Turn Pocket	250	25	155	10 ft
Single RT Turn Pocket	200	25	125	10 ft
Dual RT Turn Pocket	250	25	150	12 ft

Notes - R1 Point of curvature offset should be adjusted for intersection approaches that are skewed of an horizontal curvature. L value should be maintained and an approximately 30 degree angle for right turn traffic should be achieved.

DIRECTOR OF PUBLIC WORKS



CITY OF RANCHO CORDOVA
PUBLIC WORKS

Raised Island
Pedestrian Refuge Geometry

SCALE: 1" = XX'
DATE: JULY 2006
DRAWN BY: MATTHEW RUBLE

MIS - 03



Appendix B:
PEDESTRIAN
COUNT DETAILS





APPENDIX B

Pedestrian Count Details



Zinfandel Dr. at Highway 50 Overcrossing - 9/9/09 - 3:30 PM - 6:00 PM

Zinfandel Dr. - Pedestrian

NB

3:30		3:45	4:00	4:15	4:30	4:45	5:00	5:15	5:30	5:45
M	F	M	F	M	F	M	F	M	F	M
			1	1	1	1	1	1		

SB

3:30		3:45	4:00	4:15	4:30	4:45	5:00	5:15	5:30	5:45
M	F	M	F	M	F	M	F	M	F	M
		1	5	1	1			3	2	

Zinfandel Dr. - Bicycle

NB

3:30		3:45	4:00	4:15	4:30	4:45	5:00	5:15	5:30	5:45
M	F	M	F	M	F	M	F	M	F	M
		1		1				2	1	

SB

3:30		3:45	4:00	4:15	4:30	4:45	5:00	5:15	5:30	5:45
M	F	M	F	M	F	M	F	M	F	M
				1				1		1

Comments

3:30	None	4:45								
3:45	More people at intersection of Olson and Zinfandel so started counting that as well	5:00								
4:00	Small groups from light rail. Many college aged with backpacks probably going to	5:15								
4:15	Mostly students going SB over freeway with backpacks on 4:15-6:00	5:30								
4:30	"	5:45								

Zinfandel Dr. at Highway 50 Overcrossing - 9/9/09 - 6:45 AM - 9:00 AM

Zinfandel Dr. - Pedestrian

NB

6:45		7:00	7:15	7:30	7:45	8:00	8:15	8:30	8:45
M	F	M	M	F	M	F	M	F	M
		1			1		1		

SB

6:45		7:00	7:15	7:30	7:45	8:00	8:15	8:30	8:45
M	F	M	M	F	M	F	M	F	M
3	1	2	4	2	1	1	2	2	1

Zinfandel Dr. - Bicycle

NB

6:45		7:00	7:15	7:30	7:45	8:00	8:15	8:30	8:45
M	F	M	M	F	M	F	M	F	M
		2	1	1	2	1		1	

SB

6:45		7:00	7:15	7:30	7:45	8:00	8:15	8:30	8:45
M	F	M	M	F	M	F	M	F	M
			1	2	1	1			

6:45	None
7:00	Lady crosses 5 lanes of traffic in bike, jay walking
7:15	Lots of RT Traffic
7:30	None
7:45	Professional looking cyclist. School traffic/Backpacks

8:00	None
8:15	Jogger
8:30	None
8:45	Lady jaywalked to get to E side of road. Man pulling baby in bike ride-a-long.

Zinfandel Dr. and Olson Dr. 9/9/09 - 3:30 PM - 6:00 PM P=Pedestrian B=Bike

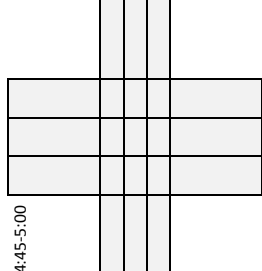
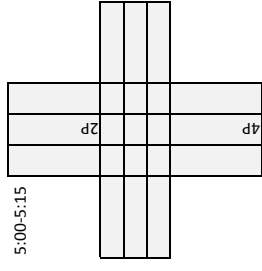
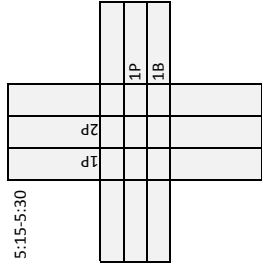
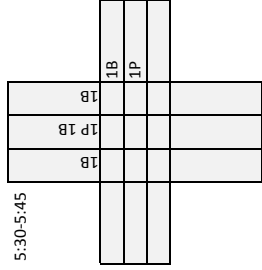
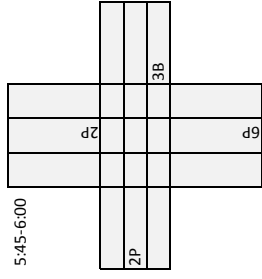
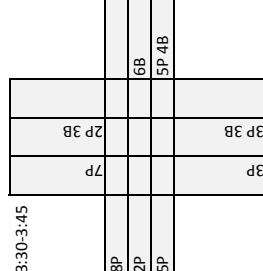
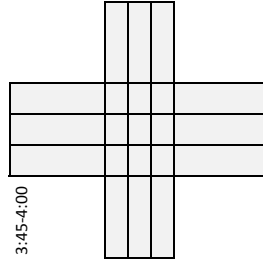
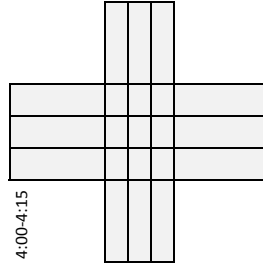
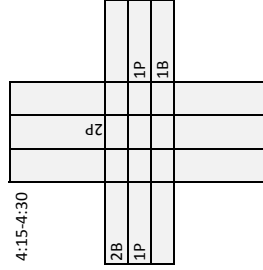
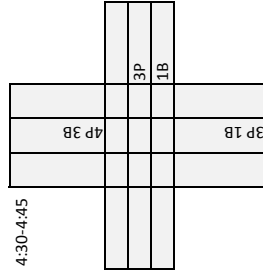

		Comments	
2:30	None	3:30	None
2:45	None	3:45	None
3:00	None	4:00	None
3:15	None	4:15	None

Zinfandel Dr. and Folsom Blvd. - 9/10/09 - 6:45 AM to 9:00 AM

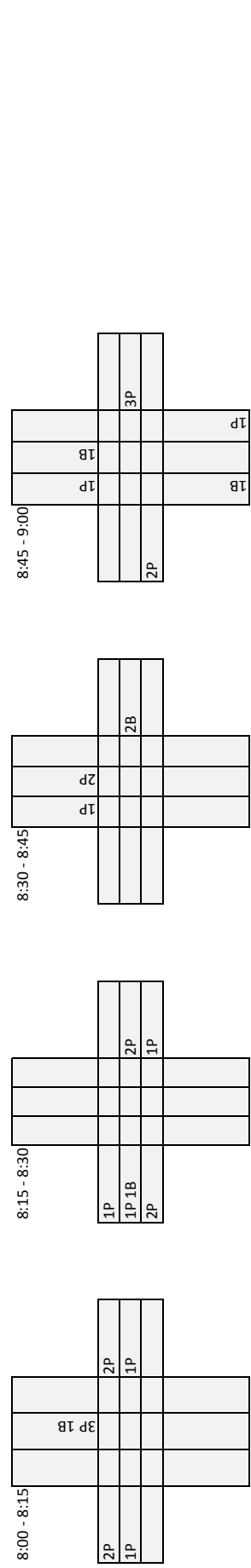
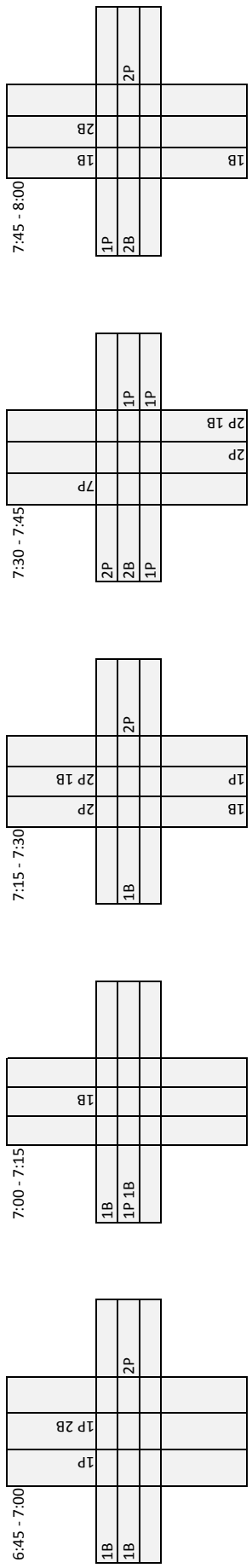

Comments	
6:45	None
7:00	None
7:15	None
7:30	None
7:45	None
8:00	None
8:15	None
8:30	None
8:45	None

Zinfandel Dr. and Benita Dr. 9/8/09 - 1:45 PM - 4:00 PM		P=Pedestrian	B=Bike
1:45- 2:00		2:00-2:15	
2:00-2:15		2:15-2:30	
2:15-2:30		2:30-2:45	
2:30-2:45		2:45-3:00	
3:00-3:15		3:15-3:30	
3:00-3:15		3:30-3:45	
3:15-3:30		3:45-4:00	
Comments			
1:45	Handicapped group of 10 and their supervisors	3:00	None
2:00	None	3:15	Woman with stroller. 2 children.
2:15	None	3:30	School traffic. 3 People with 1 stroller with infant
2:30	None	3:45	Kid purposely crossed the street to get to crosswalk in order to cross zinfandel.
2:45	Mom and 3 kids walking		

Mather Light Rail Station - 9/8/09 - 3:30 PM - 6:00 PM

Jaywalkers												
NB												
	3:30		3:45	4:00	4:15	4:30	4:45	5:00	5:15	5:30		5:45
M	F	M	F	M	F	M	F	M	F	M	F	M
				1P 1B								
SB												
	3:30		3:45	4:00	4:15	4:30	4:45	5:00	5:15	5:30		5:45
M	F	M	F	M	F	M	F	M	F	M	F	M
				1B						1P		
Folsom Blvd												
EB												
	3:30		3:45	4:00	4:15	4:30	4:45	5:00	5:15	5:30		5:45
M	F	M	F	M	F	M	F	M	F	M	F	M
				2P		3P 2B	4P 1B	5P	5P 4B	3P		3P 2B
	7P		5P 1B		11P							1P
WB												
	3:30		3:45	4:00	4:15	4:30	4:45	5:00	5:15	5:30		5:45
M	F	M	F	M	F	M	F	M	F	M	F	M
				3P 2B		8P	10P 2B	5P	3P 3B	9P		8P 1B
	9P 1B		1P	4P 6B	6P	5P 4B				5P 4B		2P
To / From Parking Lot												
NB												
	3:30		3:45	4:00	4:15	4:30	4:45	5:00	5:15	5:30		5:45
M	F	M	F	M	F	M	F	M	F	M	F	M
				7P		15P 2B	12P 2B	11P 1B	9P 1B	15P		3P 1B
	3P		10P									7P 2B
SB												
	3:30		3:45	4:00	4:15	4:30	4:45	5:00	5:15	5:30		5:45
M	F	M	F	M	F	M	F	M	F	M	F	M
				3P 3B		18P 2B	16P 4B	16P 3B	21P 2B	21P 3B		21P 5B
	10P 1B		28P 1B	20P 4B	21P 1B	20P 1B						26P
	24P 1B											26P 2B
												21P 1B
												26P 2B
												21P 5B
												26P
Crosswalk												
NL												
	3:30		3:45	4:00	4:15	4:30	4:45	5:00	5:15	5:30		5:45
M	F	M	F	M	F	M	F	M	F	M	F	M
				2P		3P 1B	4P	1P	5P			1P
	2P		1P									
WL												
	3:30		3:45	4:00	4:15	4:30	4:45	5:00	5:15	5:30		5:45
M	F	M	F	M	F	M	F	M	F	M	F	M
				2B		2P 2B	4P	3P	2P	2P		2P
	1P		1P									8P

Comments:

3:30	1 Stroller, 1 Wheelchair	4:45	Majority of people are to / from parking lot
3:45	1 Stroller, 2 Wheelchairs	5:00	1 Stroller
4:00	Lot less "J-walkers" than Zinfandel. People use Ped signal	5:15	No major development across from this LRS unlike Zinfandel LRS.
4:15	3 Strollers, 1 Wheelchair	5:30	None
4:30	2 Wheelchairs	5:45	2 Wheelchairs

Mather Light Rail Station - 9/8/09 - 6:45 AM - 9:00 AM

Crosswalk																																				
NB	6:45	M	F		7:00	M	F		7:15	M	F		7:30	M	F		7:45	M	F		8:00	M	F		8:15	M	F		8:30	M	F		8:45	M	F	
		1P	2B			1P																	2P				1P									
SB	6:45	M	F		7:00	M	F		7:15	M	F		7:30	M	F		7:45	M	F		8:00	M	F		8:15	M	F		8:30	M	F		8:45	M	F	
		2B			1P								4B				1P	1B					1B				2P									
Folsom Blvd																																				
EB	6:45	M	F		7:00	M	F		7:15	M	F		7:30	M	F		7:45	M	F		8:00	M	F		8:15	M	F		8:30	M	F		8:45	M	F	
		2B			5P	2P	4B		11P	2P	1B		5P	2B		8P	3B					10P	2B			5P	1P	2B		3P						
WB	6:45	M	F		7:00	M	F		7:15	M	F		7:30	M	F		7:45	M	F		8:00	M	F		8:15	M	F		8:30	M	F		8:45	M	F	
		1B			2P				3P	1P	3B		6P	3B		2P	2B					6P	2B		8P	4B		6P	1B							
Intersection																																				
EL	6:45	M	F		7:00	M	F		7:15	M	F		7:30	M	F		7:45	M	F		8:00	M	F		8:15	M	F		8:30	M	F		8:45	M	F	
			3P			1P																1P				1B										
NL	6:45	M	F		7:00	M	F		7:15	M	F		7:30	M	F		7:45	M	F		8:00	M	F		8:15	M	F		8:30	M	F		8:45	M	F	
		1P			1P																	1P				1B										
WL	6:45	M	F		7:00	M	F		7:15	M	F		7:30	M	F		7:45	M	F		8:00	M	F		8:15	M	F		8:30	M	F		8:45	M	F	
																						1P				1B										
SL	6:45	M	F		7:00	M	F		7:15	M	F		7:30	M	F		7:45	M	F		8:00	M	F		8:15	M	F		8:30	M	F		8:45	M	F	
			1P		1B									1B			5P						5P			4P										
Some people dropped off by car in front of the station (Not Counted). Most people coming in from west of Folsom going Eastbound to station. All bikers male over 25																																				
90% of people wearing backpacks/bags. 80% of people come in from parking lot/bus to south. All bikers male over 25																																				
majority of people off train gets on bus. People on Folsom use crosswalk farther west. One person walking WB 7:15 along median.																																				
7:30 / 75% of people counted used west side of Folsom. All bikers male over 25.																																				
7:45 None																																				

8:00	More than half of the people using intersection of bikes
8:15	Many carrying baggage/backpacks. People walking single or in groups of 2...over 50% age less than 25
8:30	Some homeless people pushing carts on North side of Folsom
8:45	None

Mather Field Rd. at Highway 50 Overcrossing - 9/10/09 - 3:30 PM - 6:00 PM

Mather Field Rd. - Pedestrian

NB

3:30		3:45	4:00	4:15	4:30	4:45	5:00	5:15	5:30	5:45
M	F	M	F	M	F	M	F	M	F	M

SB

3:30		3:45	4:00	4:15	4:30	4:45	5:00	5:15	5:30	5:45
M	F	M	F	M	F	M	F	M	F	M
		3		4	4	2	1	1		

Mather Field Rd. - Bicycle

NB

3:30		3:45	4:00	4:15	4:30	4:45	5:00	5:15	5:30	5:45
M	F	M	F	M	F	M	F	M	F	M
		1	2	1	2	1			1	2

SB

3:30		3:45	4:00	4:15	4:30	4:45	5:00	5:15	5:30	5:45
M	F	M	F	M	F	M	F	M	F	M
		2	1		1		2	1		1

Comments

3:30	None	4:45	Another kid on a skateboard.
3:45	No obvious trend in pedestrians. 2X Mid 20's males 1 on a bike and 1 guy and 1 girl walking together- low 40's. 1 low 30's SB on a bike with a backpack.	5:00	Bicyclist crossed median at freeway on ramp to change to side with sidewalk - SB
4:00	1 male mid. 30's with a backpack SB didn't appear to be on his way to school. Maybe coming home from station.	5:15	Low activity
4:15	Group of 4 kids on skateboards. Maybe going to skate park at Mather Sports Complex	5:30	Woman walking NB, late 20's prob. not going to work. Bicyclist in Bicyclist clothes - Recreational/Competitive. Maybe commuter from Folsom South Canal. Kid on scooter going NB
4:30	Teenager walking down RR tracks rather than on Mather Field Rd. over Freeway.	5:45	Brother and 2 younger sisters(?) NB WS then crossed @ Croydon over median to sidewalk ages 9, 12, 14(?)

Mather Field Rd. at Highway 50 Overcrossing - 9/8/09 - 6:45 AM - 9:00 AM

Mather Field - Pedestrian

NB

6:45		7:00	7:15	7:30	7:45	8:00	8:15	8:30	8:45
M	F	M	F	M	F	M	F	M	F
	1P		1P	1P	1P		3P		4P

SB

6:45		7:00	7:15	7:30	7:45	8:00	8:15	8:30	8:45
M	F	M	F	M	F	M	F	M	F
			3P		1P	1P			3P

Mather Field - Bicycle

NB

6:45		7:00	7:15	7:30	7:45	8:00	8:15	8:30	8:45
M	F	M	F	M	F	M	F	M	F
	1B		1B			1B	1B	1B	

SB

6:45		7:00	7:15	7:30	7:45	8:00	8:15	8:30	8:45
M	F	M	F	M	F	M	F	M	F

6:45	NB Female wrong side of road, No helmet 14-20 yrs. Old
7:00	Business man on bike. Prob. going to light rail station.
7:15	Bike wrong side of road. High School student. Man with bottles/cans. Guy jaywalked in front of stop light SB
7:30	4 ladies - 2 girls, 2 adults. Professional Bicyclist. Business lady on bike
7:45	None

8:00	Jay walking on train tracks avoiding intersection
8:15	Solo on tandem bike
8:30	None
8:45	None

Cordova Towne Light Rail Station - 9/9/09 - 3:30 PM - 6:00PM

Jaywalkers

3:30		3:45	4:00	4:15	4:30	4:45	5:00	5:15	5:30	5:45
M	F	M	F	M	F	M	F	M	F	M
1P	2P	1P	2P	1P	8P	2P	3P	4P	1P	9P

Folsom Blvd

EB

3:30		3:45	4:00	4:15	4:30	4:45	5:00	5:15	5:30	5:45
M	F	M	F	M	F	M	F	M	F	M
3P 1B	7P 5B	3P 1B	5P 2B	3P	1P	6P	4P	1P	2B	4P

WB

3:30		3:45	4:00	4:15	4:30	4:45	5:00	5:15	5:30	5:45
M	F	M	F	M	F	M	F	M	F	M
	6P		8P 3B	2P	7P 3B	1P	3P 1B	1P	5P 2B	5P

Comments:

3:30		4:45	1 Wheelchair
3:45	1 Transfer to shuttle	5:00	1 Jaywalker Cited
4:00		5:15	
4:15	2 stroller, 1 shuttle	5:30	
4:30	1 Wheelchair	5:45	Majority of Jaywalkers not going to apartments. They're going to/ from the intersection.

Cordova Town Light Rail Station 9/10/09 - 6:45 AM - 9:00 AM

Folsom Blvd												
EB												
	6:45	7:00	7:15	7:30	7:45	8:00	8:15	8:30	8:45			
M	F	M	M	F	M	F	M	F	M	F	M	F
2P 1B	2P 3B	2P 1B	1P	5P 2B	7P 2B	1B 1P	3P 1B	5P	6P 1B	4P	17P	11P
WB												
M	F	M	M	F	M	F	M	F	M	F	M	F
3P	1P	1P	6P	7P	2P 1B	2P	7P	4P 1B	5P 2B	1P	1P	1P
Intersection												
EL												
M	F	M	M	F	M	F	M	F	M	F	M	F
NL												
M	F	M	M	F	M	F	M	F	M	F	M	F
2P			1P				1P				1P	
WL												
M	F	M	M	F	M	F	M	F	M	F	M	F
3P		2P	5P	9P	6P	2P 1B	8P 2B	5P	2P	6P 1B	3P 1B	
SL												
M	F	M	M	F	M	F	M	F	M	F	M	F
			2P		1B		3P		9P		8P	4P
Comments:												
6:45	2 People observed jaywalking and hopping over fence.											
7:00	None.											
7:15	2 People observed jaywalking and hopping over fence. Most bicyclist going EB on South Side of Folsom.											
7:30	1 person observed jaywalking.											
7:45	1 person observed jaywalking.											
8:00	5 people observed jaywalking.											
8:15	People walking out on street where there is no sidewalk at rail station. 4 people observed jaywalking. Some people dropped off by car at rail station.											
8:30	Majority of people counted in this time slot are students who head EB on South side of Folsom Blvd. 11 people observed jaywalking.											
8:45	4 people observed jaywalking.											

Coloma and Chase 9/8/09 - 2:30 PM - 4:30 PM P=Pedestrian B=Bike

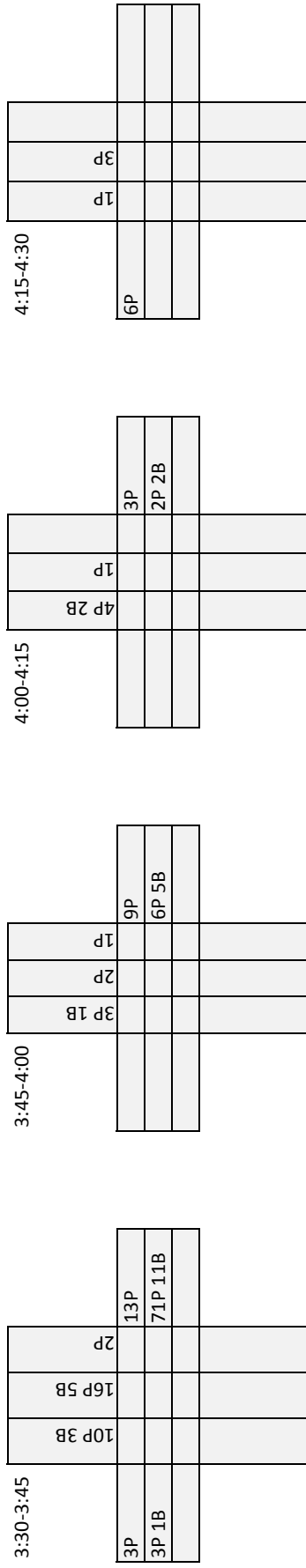
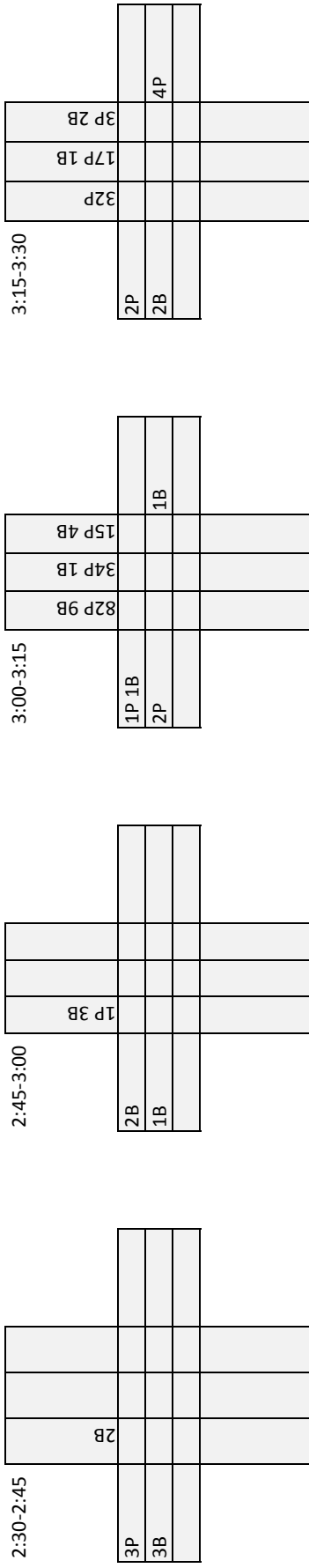

Comments

2:30	Mostly school aged kids riding their bikes down Coloma. Over 13 yrs old less than 18	3:30	Junior High School must have dismissed. Big influx of students from East direction. Higher percentage of students on bicycles.
2:45	Noticed some school aged kids turning onto Chase from side streets close to Coloma. Assume to avoid the high speed and volume on Coloma	3:45	Pedestrian traffic ended the busy phase. Many bicyclists no waiting for light when traveling WB on Coloma crossing Chase on the north side of Coloma.
3:00	Big influx of students. Many cross straight south then down Coloma against traffic.	4:00	Some students walk along inside of fence WB north side to Chase then turn right. Harder to see and track. Vendor packed up and left.
3:15	Vendor opened food and ice cream stand on corner. Could cause some students to go to this corner then cross that normally wouldn't. Also students gathered around making it difficult to count them.	4:15	ROTC must have dismissed. A few students in uniform.

Coloma and Chase 9/8/09 - 7:15AM - 9:15 AM P=Pedestrian B=Bike

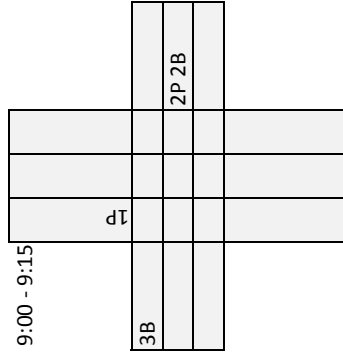
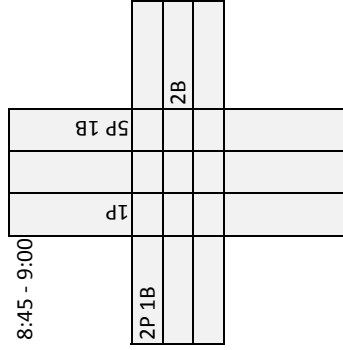
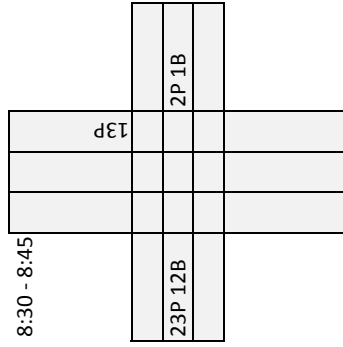
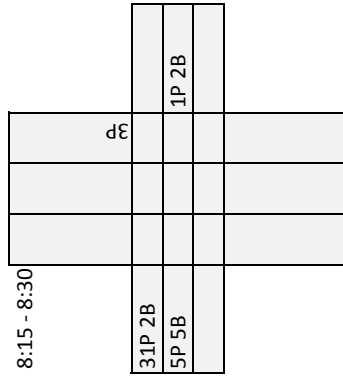
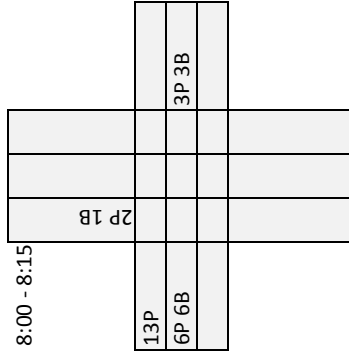
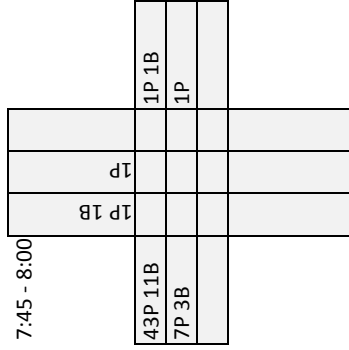
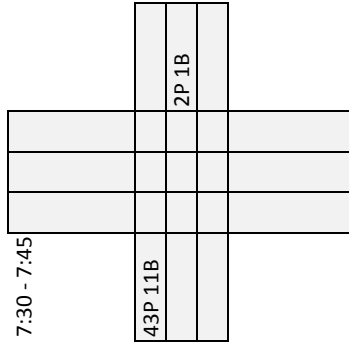
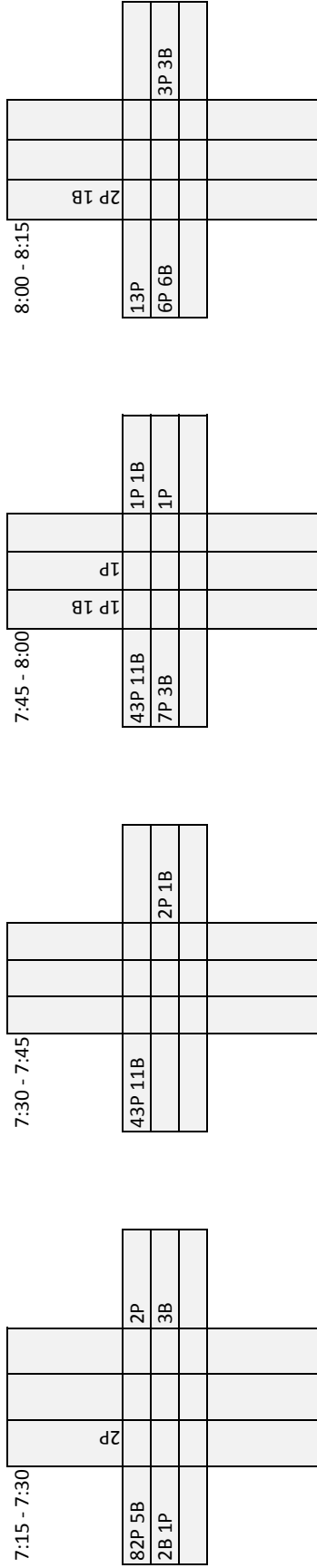

Comments

7:15	Mixture of Males/Females	8:15	Kids continually walking through field
7:30	Some kids walked EB through track field toward middle school	8:30	Kids cutting through field
7:45	Kids going through field	8:45	1 family going to school track field
8:00	Kids look like they're going NB and then cut through field. Kids walking WB and EB through field	9:00	

Zinfandel Light Rail Station - 9/10/09 - 3:30 PM - 6:00PM

Jaywalkers

3:30		3:45	4:00	4:15	4:30	4:45	5:00	5:15	5:30	5:45
M	F	M	F	M	F	M	F	M	F	M
1P	1P	1P	1P	1P	1P	1P	1P	1P	1P	1P

Folsom Blvd

EB

3:30	3:45	4:00	4:15	4:30	4:45	5:00	5:15	5:30	5:45										
M	F	M	F	M	F	M	F	M	F										
5P 3B	6P	5P	5P 1B	1P	7P	2P	2P	4P 3B	3P 1B	8P 1B	4P	6P 1B	5P	1P 2B	5P	4P 3B	5P 1B	7P 1B	5P

WB

3:30	3:45	4:00	4:15	4:30	4:45	5:00	5:15	5:30	5:45											
M	F	M	F	M	F	M	F	M	F											
11P 3B	9P	5P	1P	8P 1B	6P	6P	6P 1B	2P	5P 2B	1P	8P 2B	3P	6P 2B	5P	2P 2B	4P	5P 2B	2P	6P 2B	3P 1B

Comments:

3:30	1 Stroller	4:45	1 Stroller, 1 Wheelchair
3:45		5:00	1 Stroller
4:00		5:15	1 Stroller
4:15		5:30	
4:30		5:45	

